

# SG 1003M

---

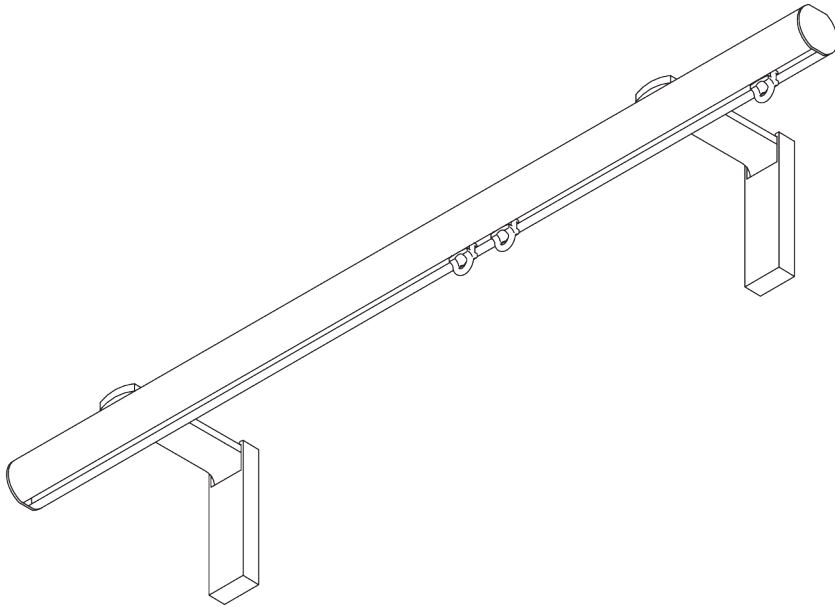
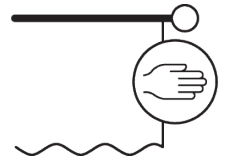

## PRODUCT INFORMATION

- **Operation:** hand
- **Range:** S
- **Fitting:** ceiling, wall
- **Colours:** white RAL 9016, various colours / finishes
- **Fabrics:** refer to Silent Gliss fabric collection

### **Features:**

- Matching endcaps and brackets / bracket covers
- Range of decorative finials
- Bendable

# SYSTEM SPECIFICATIONS

## A. PROFILE

Profile and bending information

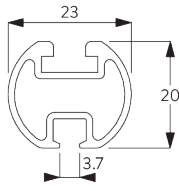

SG 1003p

Profile



## B. HOW TO MEASURE

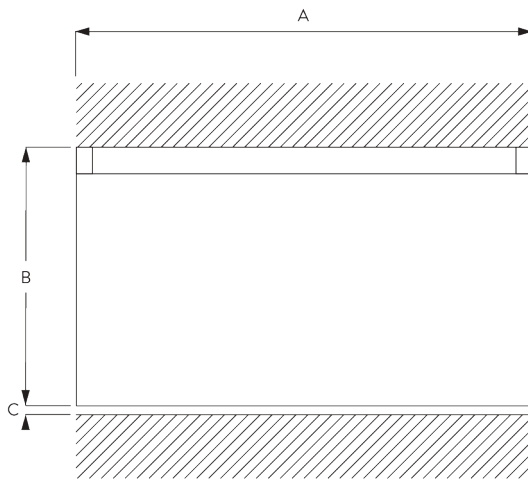

A: System width includes finials

B: System height

C: Distance between floor and fabric

## C. SPECIFICATION

### TEXT

**Silent Gliss SG 1003 'Metropole' hand operated curtain track system.** Comprises 23mm round aluminium profile SG 1003 supplied made to measure with gliders SG 3533 at 16/m, 2no. end stops SG 3070 and 2 no. flush end covers SG 20339. Straight poles supplied as standard with wall 'face' fix Smart Fix brackets SG 11206 at max. 600mm centres. Optional wall fix brackets SG 11207-11208 / SG 11216-11218 / SG 11209 / Maxi bracket SG 20334 / Blok bracket SG 20989. Bent systems for wall 'face' fix supplied as standard with adjustable Smart Fix bracket SG 11209. Ceiling 'top' fix with bracket SG 6151 / SG 20335 at max. 600mm centres. Finished in White, Matt White, Ecru, Silver Anodised, Gunmetal, Charcoal and Chrome Effect. A range of decorative finials are available.

# FITTING

## A. FITTING INFORMATION

Fixing points

For detailed fitting information, visit the [Silent Gliss website](#).

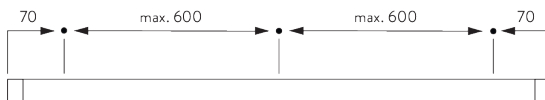

**B. CEILING FITTING**

**Support SG 6151**

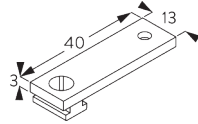
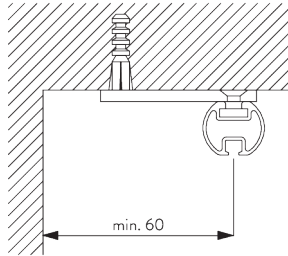

**SG 6151**

*Ceiling support set 3 mm*

**Top fix bracket SG 20335**

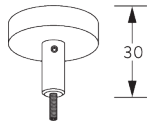
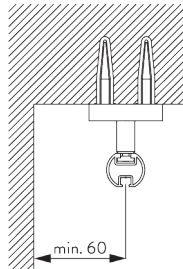

**SG 20335**

*Top fix bracket*

**C. WALL FITTING**

**Smart Fix**

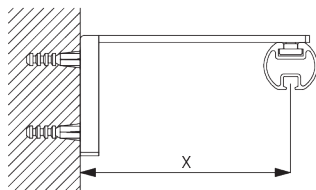

**Smart Fix with slot SG 11206 - SG 11208 and SG 6141:**  
*Screw SG 20798 (M4x10) needed.*

<b>Smart Fix</b>	<b>X mm</b>
SG 11206 / SG 11216	51
SG 11207 / SG 11217	71
SG 11208 / SG 11218	91
SG 11209 / SG 11472	80-100

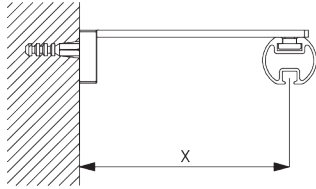

**Square Smart Fix with slot SG 11216 - SG 11218 and SG 6141:**

Screw SG 20798 (M4x10) needed.

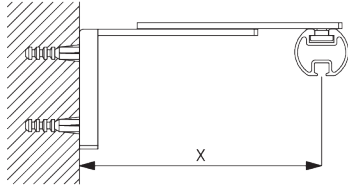

**Adjustable Smart Fix SG 11209 and SG 6141:**

Screw SG 20798 (M4x10) needed.

*Note: all bent Metropole systems are supplied with adjustable bracket SG 11209 as standard.*

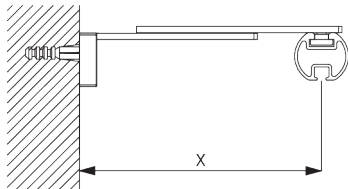

**Adjustable Square Smart Fix SG 11472 and SG 6141:**

Screw SG 20798 (M4x10) needed.

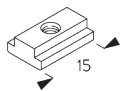

**SG 6141**

Clamping piece

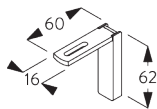

**SG 11206**

Smart Fix with slot 60 mm

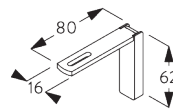

**SG 11207**

Smart Fix with slot 80 mm

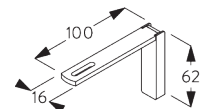

**SG 11208**

Smart Fix with slot 100 mm

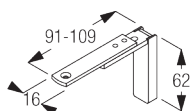

**SG 11209**

Adjustable Smart Fix

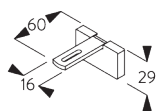

**SG 11216**

Square Smart Fix with slot 60 mm

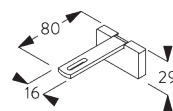

**SG 11217**

Square Smart Fix with slot 80 mm

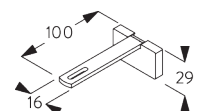

**SG 11218**

Square Smart Fix with slot 100 mm

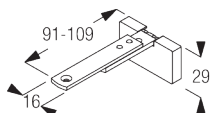

**SG 11472**

Adjustable Square Smart Fix



**SG 20798**

Hexagon socket countersunk screw M4x10 mm

**Blok bracket  
SG 20989**

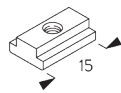
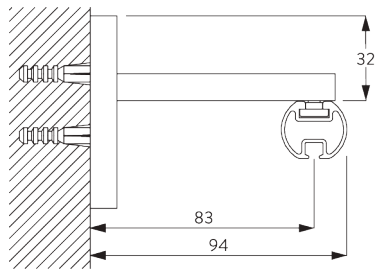

**SG 6141**  
Clamping piece

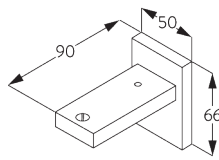

**SG 20989**  
Blok bracket

# DESIGN OPTIONS

## A. ENDCAPS

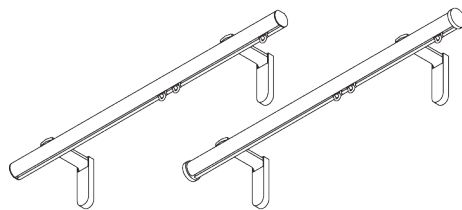

Without finials, poles are supplied as standard with flush fitting endcaps SG 20339 (left).

Alternatively, stud endcaps SG 20706 (right) can be selected at no additional cost.

## B. FINIALS

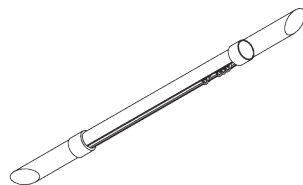

Finials are decorative elements that fit on at the end of the pole.

Please refer to the *Metropole brochure* for full range details.

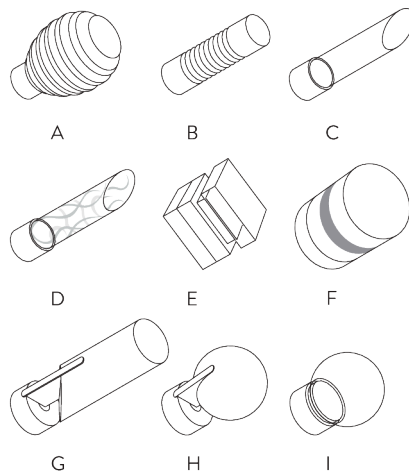

- A: SG 20985 Groove Ball 85 mm
- B: SG 20628 Groove Cylinder 80 mm
- C: SG 20993 Shard (clear) 112 mm
- D: SG 20993 Shard (etched) 112 mm
- E: SG 20884 Crystal Cube 33 mm  
(green, black, brown)
- F: SG 20894 Crystal Cylinder 55 mm  
(green, black, brown)
- G: SG 20308 Fused Barrel 90 mm  
(walnut, oak, colour matched)
- H: SG 20321 Fused Ball 48 mm  
(walnut, oak, colour matched)
- I: SG 20329 Glass Ball 45 mm  
(clear, frosted)

# GENERAL NOTES

## **Dimensions**

- Measurements are in mm except where indicated.
- Max. kg relates to fabric incl. accessories.
- Stack size depends on curtain make-up and fabric thickness.
- Distance between gliders max. 80 mm / distance between rollers max. 100 mm.
- Recommended distance floor / fabric: 20 mm.
- In order to determine system height (B), the smallest room height must be taken into account.

## **Fitting**





- Installation by qualified fitter only.
- Number of brackets and fitting positions / fixing points vary depending on fitting surface, system weight, fabric make-up, screw / fixing type and obstacles.
- Qualified fitter must use appropriate screws / fixings for each situation.
- Profile lip if applicable to be installed to room side.

## **Child Safety**





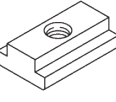
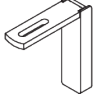

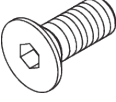
- All relevant Silent Gliss systems correspond to child safety EN 13120.
- All parties involved must comply with EN 13120.

# PARTS

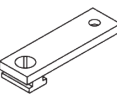
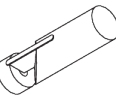
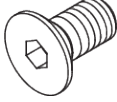
## A. STANDARD PARTS

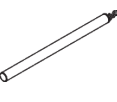
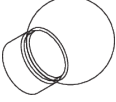
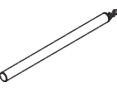
	<b>SG 1003p</b> Profile
	<b>SG 3070</b> End stop
	<b>SG 3534</b> Glider 3533 on strip
	<b>SG 6141</b> Clamping piece
	<b>SG 11206</b> Smart Fix with slot 60 mm
	<b>SG 20339</b> Flush endcap 23 mm
	<b>SG 20798</b> Hexagon socket countersunk screw M4x10 mm

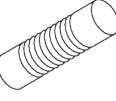
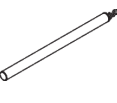
## B. OPTIONAL PARTS

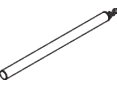
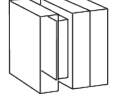
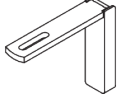
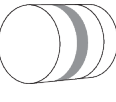
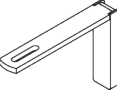
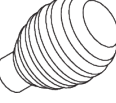
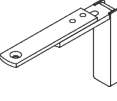
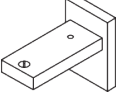
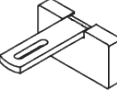
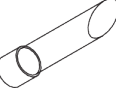
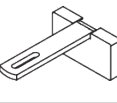
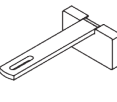
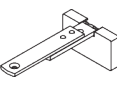
	<b>SG 6151</b> Ceiling support set 3 mm		<b>SG 20308</b> Fused barell 90 mm
	<b>SG 6784</b> Hexagon socket countersunk screw M4x8 mm		<b>SG 20321</b> Fused ball 48 mm
	<b>SG 10430</b> Draw rod 50 cm		<b>SG 20329</b> Glass ball 45 mm
	<b>SG 10431</b> Draw rod 75 cm		<b>SG 20335</b> Top fix bracket
	<b>SG 10432</b> Draw rod 100 cm		<b>SG 20628</b> Groove cylinder 80 mm
	<b>SG 10433</b> Draw rod 125 cm		<b>SG 20706</b> Stud endcap 23 mm
	<b>SG 10434</b> Draw rod 150 cm		<b>SG 20884</b> Crystal cube 33 mm
	<b>SG 11207</b> Smart Fix with slot 80 mm		<b>SG 20894</b> Crystal cylinder 55 mm
	<b>SG 11208</b> Smart Fix with slot 100 mm		<b>SG 20985</b> Groove ball 85 mm
	<b>SG 11209</b> Adjustable Smart Fix		<b>SG 20989</b> Blok bracket
	<b>SG 11216</b> Square Smart Fix with slot 60 mm		<b>SG 20993</b> Shared glass 112 mm
	<b>SG 11217</b> Square Smart Fix with slot 80 mm		
	<b>SG 11218</b> Square Smart Fix with slot 100 mm		
	<b>SG 11472</b> Adjustable Square Smart Fix		