

Hand Operated Curtain Pole System

Silent Gliss® 1003M Metropole 23mm

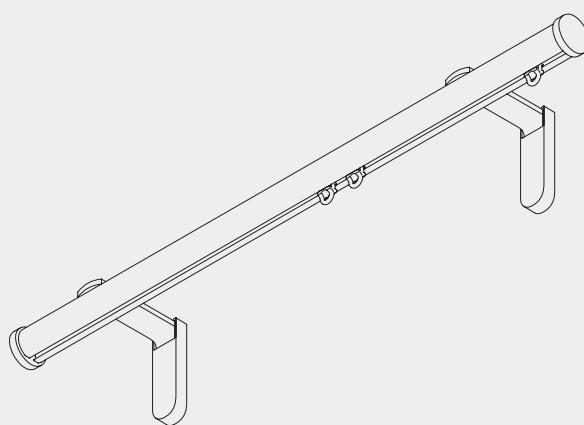

Product Information

- Hand operated decorative curtain poles for domestic and contract applications
- Ideal for bay windows
- For light to medium weight curtains
- Made to measure
- Profile length 6m (chrome effect 3.95m)
- 6 different finishes - black, silver, chrome effect, gunmetal, taupe and white
- Range of decorative finial and midial designs in different styles and colours
- Midial designs can also be used with holdback arms to create an attractive additional feature
- Wall fix or ceiling fix
- Unlike other poles, 1003 can be bent to a small radius for bay windows etc. whilst retaining efficient operation



1003M

Profile, Bending and Specification Information

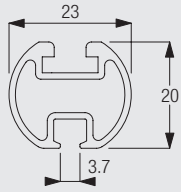

1003



Standard radius 150mm

Specification Guide - download from www.silentgliss.co.uk (password required).

Silent Gliss 1003 curtain track, hand drawn, aluminium, assembled complete with gliders 3533 at 16/m, 2 endcovers 0706 and 2 endstops 3070. Face fix with brackets 3134/6. Top fix with support 6138P. Available in black, white, silver, gunmetal, taupe and chrome effect.

Design Options

Finials

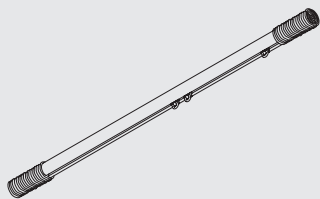

Finials are decorative elements that fit at the end of the pole.

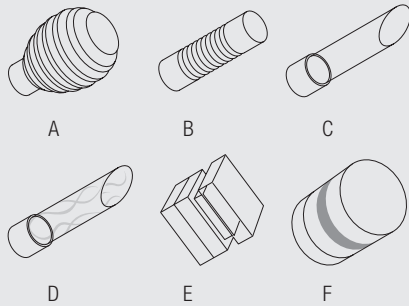

- A: 0985 Groove Ball 85mm
- B: 0628 Groove Cylinder 80mm
- C: 0993CL Shard (clear) 112mm
- D: 0993ET Shard (etched) 112mm
- E: 0884 Crystal Cube 33mm (green, black, brown)
- F: 0894 Crystal Cylinder 55mm (green, black, brown)

Without finial, endcaps with matching colour of the pole will be applied. Please refer to the specific Metropole brochure for more detail and colour descriptions.

Midials

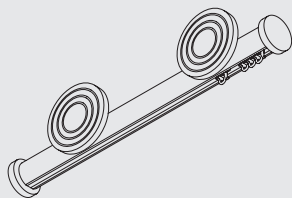

Midials are a curtain pole decoration projecting in front of the pole.

Please refer to the specific Metropole brochure for more detailed and colour descriptions.

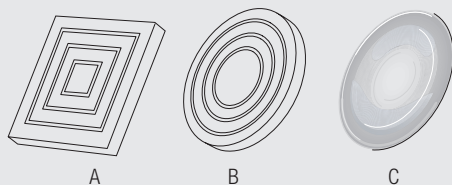

- A: 0M800 Vega Square (80mm)
- B: 0M900 Vega Circle (80mm)
- C: 0M400 Discus Glass (100mm - red, white, amber, purple, lilac)

Holdbacks

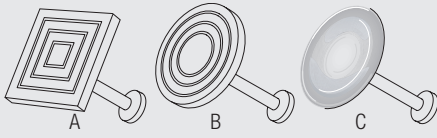

Midial designs can be used on matching holdback arms.

Please refer to the specific Metropole brochure for more detailed and colour descriptions.

- A: OHB80 Vega Square 80mm
- B: OHB90 Vega Circle 80mm
- C: OHB40 Disc Glass (red, white, amber, purple, lilac) 100mm

Fitting Information

Bracket positioning when using standard brackets 3134-3136 or Ultra brackets 6133/6134



Fitting of track to brackets

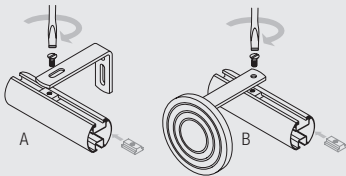

- A: Using brackets 3134/2 - 3136/2
- B: Using midial bracket 0797A

Fitting Options

Wall fix with brackets 3134-36/2

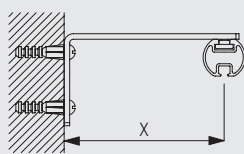

	X (mm)
3134/2	52
3135/2	72
3136/2	92

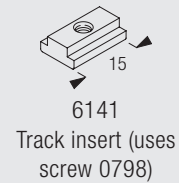
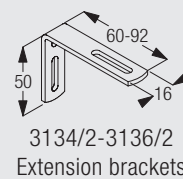

Ceiling fix with support 6138P

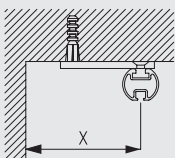

X (mm)
80-100

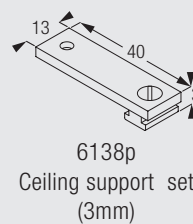

Please note: for ceiling fixing with midials, use bracket 3134/b

The final distances may be outside of the recommendations above depending on curtain make-up and any obstructions.

Wall fix with adjustable bracket 0537

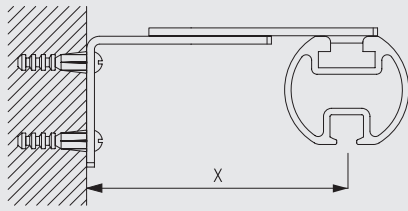

	X (mm)
0537	80-100

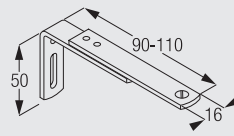

0537
Adjustable bracket

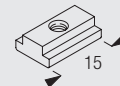

6141
Track insert (uses
screw 0798)

Standard Accessories

0706	End cover (1003)		1003	Profile	
3070	Twist eye endstop		3133	Bracket cover (60mm)	
3534	Glider 3533 in strip form		6141	Track insert (uses screw 0798)	
6784	Machine screw (for 6141 insert)		3134/2	Pole extension bracket (60mm - all colours)	

Optional Accessories

0537	Adjustable bracket		0628	Groove Cylinder (23mm)	
0732	Hexagonal nut		0733	M6 washer for midial	
0884	Crystal cube (23mm pole)		0894	Crystal cylinder (23mm)	
0985	Groove Ball (23mm)		0989	Blok Bracket	
3582	Hook		0797A	Midial bracket	
0HB80	Vega square holdback		0HB90	Vega circle holdback	
0M800	Vega square midial		0M900	Vega circle midial	
10430	Draw rod with hook, 50cm		10431	Draw rod with hook, 75cm	
10432	Draw rod with hook, 100cm		10433	Draw rod with hook, 125cm	
10434	Draw rod with hook, 150cm		3134/b	Midial ceiling fix bracket	



1003M

3135/2

Pole extension bracket (80mm - all colours)



3136/2

Pole extension bracket (100mm - all colours)



6138p

Ceiling support set (3mm)



0993CL

Shard Clear (23mm)

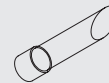

0993ET

Shard Etched (23mm)

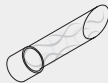

1003M