

# Hand Operated Curtain Track System

## Silent Gliss® 1025

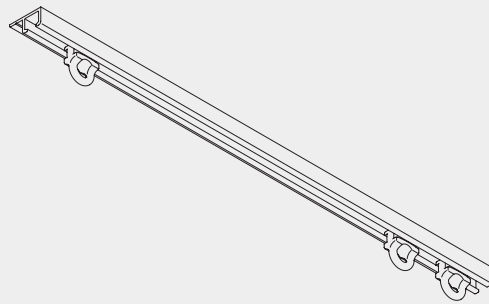

### Product Information

- Discreet ceiling fix track ideal for mounting preferably to wood
- Widely used for aircraft, trucks, boats, caravans
- For light curtains and nets
- Pre-drilled every 300mm
- Standard colours: silver, white
- Standard profile lengths: 5m silver only, 6m silver, white
- Can be bent



1025

## Profile, Bending and Specification Information

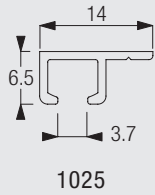

We recommend the standard radius for optimal operation, but the minimum possible radius is 60mm.

Specification Guide - download from [www.silentgliss.co.uk](http://www.silentgliss.co.uk) (password required).

Silent Gliss 1025 curtain track, hand-drawn, anodised aluminium, complete with gliders 3533 at 16/m. nd 2 stops 3016 per length, top fixed to timber (by others) at 300mm. centres with special screw 6835. ....Lm.

## Fitting Information

### Fixing points



The fixing distances are meant as a guide only: they may vary in practice depending on the surface and curtain weight.

## Fitting Options

### Ceiling fix to timber with single profile

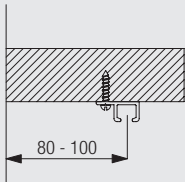

### Ceiling fix to timber with two or multiple profiles

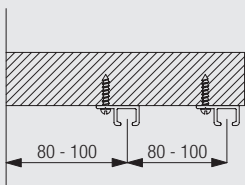

The final distances may be outside of the recommendations above depending on curtain heading, make-up and any obstructions. Batten thickness depends on length of screw.

## Standard Accessories

1025 Profile



3016 Endstop



3534 Glider 3533 in strip form



6835A Special roundhead screw 12mm No. 4

## Optional Accessories

3017 Endstop



3032 Spring stop



3070 Twist eye endstop



3071 Screw twist endstop



3511 Glider



3532 Glider



3533 Glider



3548 Retrofit glider



3570 Rotating glider



3580 Side mounted glider/hook



10430 Draw rod with hook, 50cm



10431 Draw rod with hook, 75cm

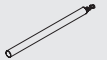

10432 Draw rod with hook, 100cm



10433 Draw rod with hook, 125cm

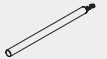

10434 Draw rod with hook, 150cm



6835B Special roundhead screw 24mm No.4

6835C Pozidrive screw 12mm No.4



1025

## Useful Information and Sewing Accessories

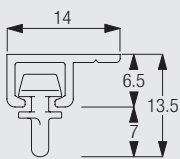

Diagram uses standard 3533/3534 glider and is measured to the inside of the glider eye. For optional gliders substitute dimensions below:

3570 = 6.0mm

3548 = 7.5mm

3068 Loop tape



3571 Hook



3582 Hook



3599 Hook



Supplied by

**SG-S** | **Silent Gliss Spares**  
**Silent Gliss Systems**

www.sg-s.co.uk email: sales@sg-s.co.uk tel: 01395 232528

[www.silentgliss.co.uk](http://www.silentgliss.co.uk)

[www.silentglissglobal.com](http://www.silentglissglobal.com)

Silent Gliss Ltd  
Pyramid Business Park  
Poorhole Lane  
Broadstairs  
Kent  
CT10 2PT  
Great Britain

Tel: +44 (0) 1843 863571  
Fax: +44 (0) 1843 864503  
info@silentgliss.co.uk

Silent Gliss Global Ltd  
Pyramid Business Park  
Poorhole Lane  
Broadstairs  
Kent  
CT10 2PT  
Great Britain

Tel: +44 (0) 1843 874250  
Fax: +44 (0) 1843 874457  
info@silentglissglobal.com