

Hand Operated Curtain Track System

Silent Gliss® 1225

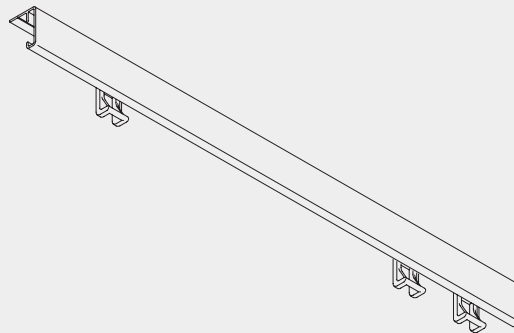

Product Information

- Robust ceiling fix hand operated curtain track for medium weight curtains in contract applications
- Ideal and widely used for hotels, schools, hospitals, etc
- Outstanding gliding properties as glider moves on profile edge, minimizing friction
- The quick-clip gliders 3933 can be easily added or removed without taking track down or apart
- Discreet direct to ceiling fixing to all surfaces. Profile is pre-drilled every 300mm
- Standard colour: white powder coated
- Standard length of the profiles is 5m and 6m



1225

Profile Information

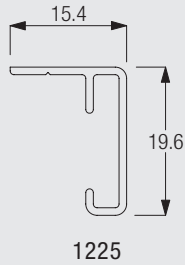

Cannot be bent

Specification Guide - download from www.silentgliss.co.uk (password required).

Silent Gliss 1225 hand drawn curtain track in white powder coated aluminium. Fix track to ceiling with screws at every 30cm to timber or plugged and screwed to blockwork. Special gliders 3933 should be fixed at 14/m to run on back rims of channel so as to keep curtain hanging upright. Fix with secure end covers 3984 at either end.

Fitting Information

Fixing points

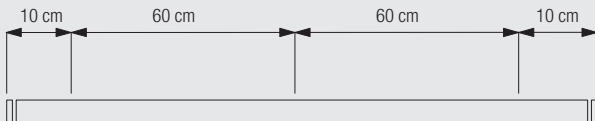

The fixing distances are meant as a guide only: they may vary in practice depending on surface and curtain weight.

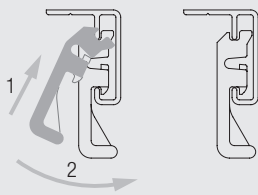

Quick-clip glider 3933 offers easy clipping in and out of profile.



1225

Fitting Options

Direct to ceiling fixing

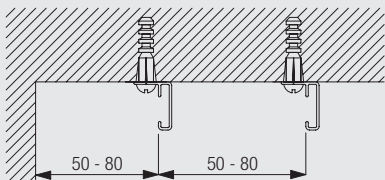

The final distances may be outside of the recommendations above depending on curtain heading, make-up and any obstructions. Batten thickness depends on length of screw.

Standard Accessories

1225 Profile



3933 Glider 3933 in strip form



3984 Endcover



Optional Accessories

18R Screw 25mm. No. 8 roundhead

3942 Endstop



10430 Draw rod with hook, 50cm



10431 Draw rod with hook, 75cm

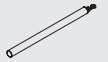

10432 Draw rod with hook, 100cm



10433 Draw rod with hook, 125cm

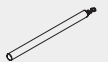

10434 Draw rod with hook, 150cm



Sets

3947 Pair of magnetic gliders

3945 Magnetic glider (part of set 3947) 1



3946 Magnetic glider (part of set 3947) 1



1225

Useful Information and Sewing Accessories

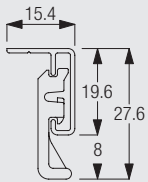

Diagram uses standard 3933 glider and is measured to the inside of the glider eye. For optional gliders substitute dimensions below:
3945/3946 = 8mm

3562 Standard tape



3582 Hook



3599 Hook

