

Chain Operated Roman Blind System

Silent Gliss® 2120

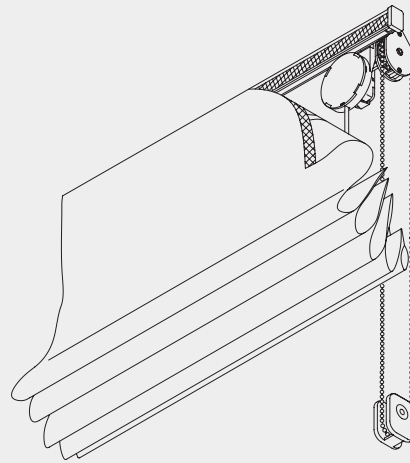

Product Information

- Delivered ready-assembled to exact size for attaching to blind and fitting
- For blinds up to 4m in width and a drop of up to 6m
- The endless bead chain operation makes 2120 ideal for blinds which are large or inaccessible or where trailing cords are not suitable
- Left or right hand pull
- Blinds weighing up to 8kg can be effortlessly operated
- No locking-off required - blind stops without slipping at any required position
- Simple ceiling or wall fixing
- With universal joint 2072A, blinds for bay windows can be achieved in one system
- Single or double bends are possible up to 4m with weight limitations
- Compliant with Child Safety Legislation (EN13120)



2120

Supplied by

SG-S | Silent Gliss Spares
Silent Gliss Systems

www.sg-s.co.uk email: sales@sg-s.co.uk tel: 01395 232528

Profile, Bending and Specification Information

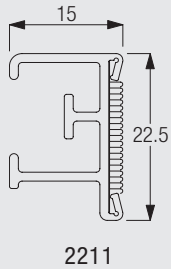

Specification Guide - download from www.silentgliss.co.uk (password required).

Silent Gliss 2120 chain operated headrail system for Roman/Austrian blinds. Ready assembled with Silent Gliss fabric colour / for customer to attach own fabric. Headrail 2211 fixed with standard accessories according to Silent Gliss main catalogue. Bead chain operation, left hand pull/right hand pull via 2049 gear drive. Take-up reel 2081 atcm centres supplied with drawing tape 2163.

System Dimensions



4m



6m



24



8kg

Max 1.25kg per spool

The system dimensions depend on the total fabric weight including the bottom bar, lead weight tapes and cross rods (for hard fold roman blinds).

Fitting and Sewing Information

WARNING



2120

Young children can be strangled by loops in pullcords, chains, tapes and inner cords that operate the product. To avoid strangulation and entanglement, keep cords out of the reach of young children. Cords may become wrapped around a child's neck. Move beds, cots and furniture away from window covering cords. Do not tie cords together. Make sure cords do not twist to create a loop.

Bracket positioning and fixing

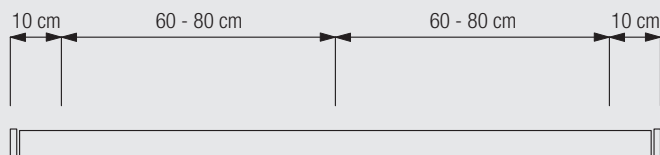

The effective measurements are determined by the actual height, width, structure and make-up style of the curtain.

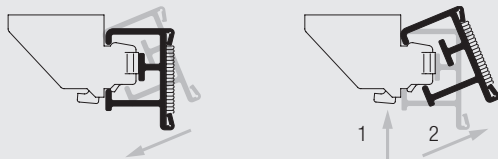

Applicable with brackets 3603/3630/3655/3660

Installation: Roll track onto bracket in direction indicated.
Removal: 1. Press to release 2. Rotate forward for removal.

Fixing of cords / tapes

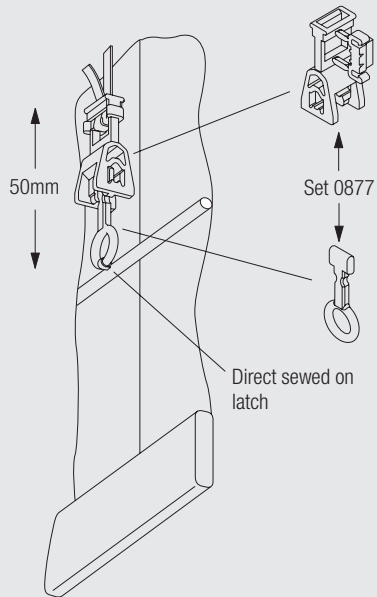

Using Breakaway Bottom Bar Set 0877

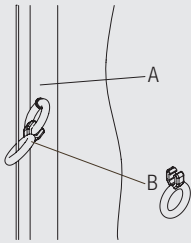

Soft fold:

A: Breakaway Ring Tape Set 0879
B: Set includes Child Safety Eyelet

Note: The Breakaway Ring Set is available without tape (part number 0878).

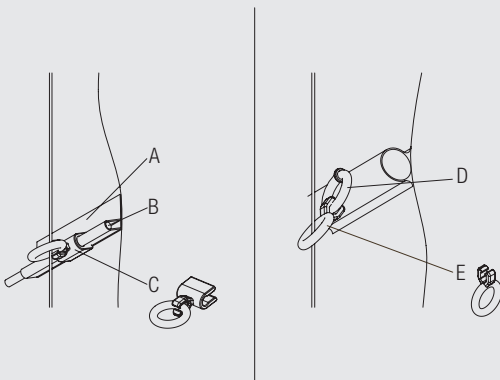

Hard fold:

A: Tape 2136
B: Steel rod 2135
C: Child Safety Eyelet (hard fold) 3069

D+E: Breakaway Ring Set 0878



2120

Fitting Options

Ceiling fix with bracket 3603

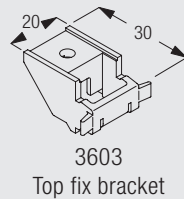
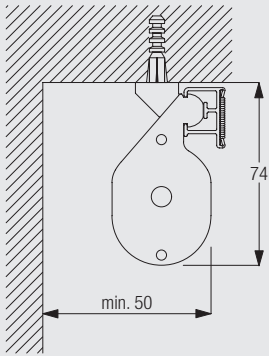

Wall fix with brackets 3630, 3655 and 3660

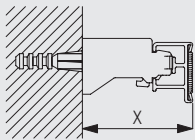

	x
3630	43mm
3655	58mm
3660	73mm

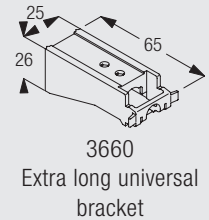
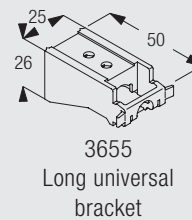
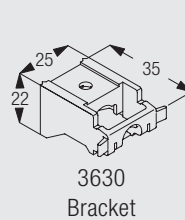

Wall fitting with Smart Fix 11200-11205 and bracket 3603

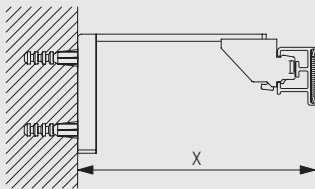

	x (mm)
11200	80
11201	100
11202	120
11203	140
11204	170
11205	220

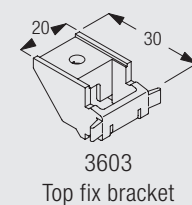
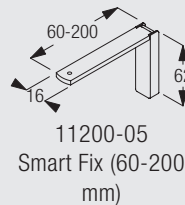

Brackets feature thread for screw SG 10492 (M4x8) for fixing bracket SG 3603.

Wall fitting with Square Smart Fix 11210-11215 and bracket 3603

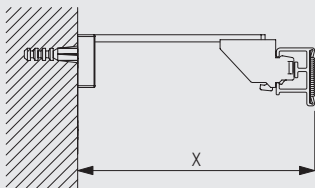

	X (mm)
11210	80
11211	100
11212	120
11213	140
11214	170
11215	220

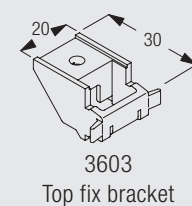
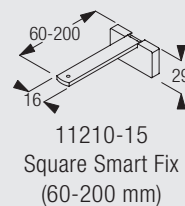

Brackets feature thread for screw SG 10492 (M4x8) for fixing bracket SG 3603.

Wall fitting with Universal Smart Fix 11154-11156 and bracket 3603

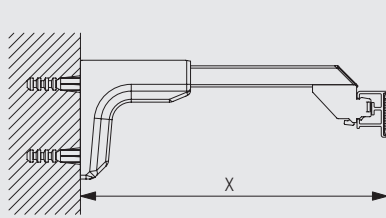

	X (mm)
11154	132-160
11155	162-190
11156	212-240

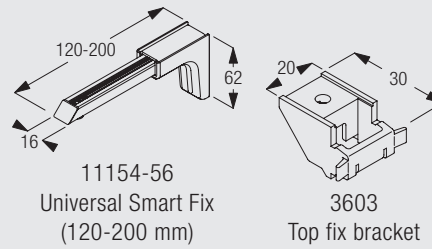

Brackets feature thread for screw SG 10277 (M4x12) for fixing bracket SG 3603.

Standard Accessories

2049	Gear drive		2059	Safety clip	
2081	Take-up reel		2111	Hexagonal bar	
2163	Flat drawing tape		2179	Endcover (24.8mm)	
2211	Velcro profile		2865	Bead chain connector	
3630	Bracket		4845	Metal bead chain	
10400	Safety Cord Retainer				



2120

For general fabric make-up and components see system 2100

Optional Accessories

2006	Weight bar		2048	Plastic bead chain	
2579	Auxiliary brake		3603	Top fix bracket	
3655	Long universal bracket		3660	Extra long universal bracket	
11154	Universal Smart Fix, 120 mm set		11155	Universal Smart Fix, 150 mm set	
11156	Universal Smart Fix, 200 mm set		11200	Smart Fix, 60 mm set	

11201 Smart Fix, 80 mm set



11202 Smart Fix, 100 mm set

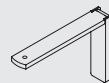

11203 Smart Fix, 120 mm set

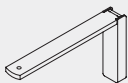

11204 Smart Fix, 150 mm set



11205 Smart Fix, 200 mm set



11210 Square Smart Fix, 60 mm set



11211 Square Smart Fix, 80 mm set



11212 Square Smart Fix, 100 mm set

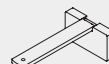

11213 Square Smart Fix, 120 mm set

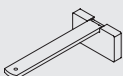

11214 Square Smart Fix, 150 mm set

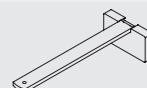

11215 Square Smart Fix, 200 mm set

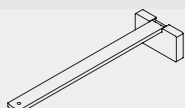

Sewing Accessories

2135 Steel rod



2136 Rod Tape



3069 Breakaway rod cover (hard fold)



3164 Breakaway bottom bar set (was 0877)

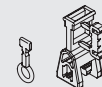

3165 Breakaway ring set for soft fold (was 0878)



3166 Breakaway ring tape for soft fold (was 0879)



2120

Supplied by

SG-S

Silent Gliss Spares
Silent Gliss Systems

www.sg-s.co.uk email: sales@sg-s.co.uk tel: 01395 232528

Silent Gliss®

Supplied by



www.sg-s.co.uk email: sales@sg-s.co.uk tel: 01395 232528

www.silentgliss.co.uk

www.silentglissglobal.com

Silent Gliss Ltd
Pyramid Business Park
Poorhole Lane
Broadstairs
Kent
CT10 2PT
Great Britain

Tel: +44 (0) 1843 863571
Fax: +44 (0) 1843 864503
info@silentgliss.co.uk

Silent Gliss Global Ltd
Pyramid Business Park
Poorhole Lane
Broadstairs
Kent
CT10 2PT
Great Britain

Tel: +44 (0) 1843 874250
Fax: +44 (0) 1843 874457
info@silentglissglobal.com