

Chain Operated Roman Blind System

Silent Gliss® 2305

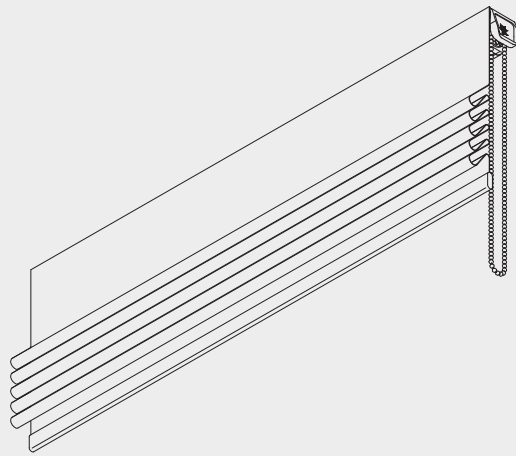

Product Information

- Chain operated
- Gear 1:4
- Integrated magnetic child safety endset
- All working parts concealed in headbox
- Left or right hand operation
- Corresponds to safety norms EN 13120, EN 16433 and EN 16434 - breakaway devices for inner cords included
- Ceiling and wall fitting

2305

Profile and Bending Information

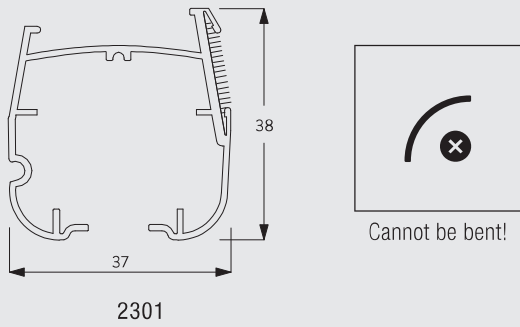

Specification text

Silent Gliss 2305 Roman Blind Headrail System. Headrail 2301 in white with bonded hook and loop insert. Includes spools with cord 2308. Metal bead chain operated 2311, (optional plastic chain 2310). Left/right hand pull via child safety gear drive set 2307 includes endcap, (optional gear drive set without child safety mechanism 2317 supplied with chain retainer). Top/face fix using clip bracket 2302 at 80cm centres (optional face/top fix clamp bracket 2346). Includes bottom weight bar 2004. When supplied with fabric includes Hook & Latch set 0877. Fabric to be attached to profile using loop tape. Compliant to Child Safety Legislation EN 13120

How To Measure

Breakaway child safety chain drive SG 2307

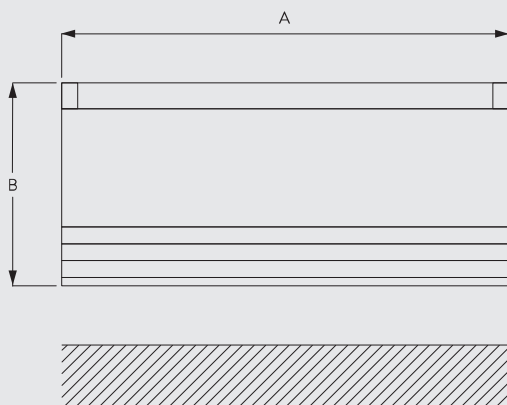

- A: System width
- B: System height
- C: Chain drop
- D: With breakaway - min. 60 cm above floor

Non-breakaway chain drive SG 2317

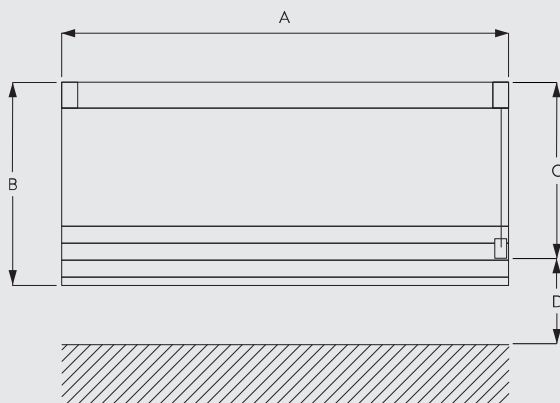

- A: System width
- B: System height
- C: Chain height
- D: Safety retainer SG 10400 used together with non-breakaway chain drive SG 2317; min. 150 cm above floor

System Dimensions

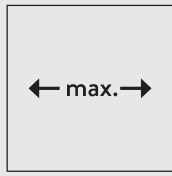

3.0 m

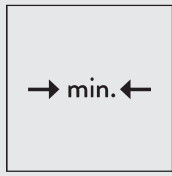

0.6 m

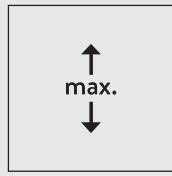

3.4 m



4.0 kg

Fitting and Sewing Information

Fixing Points

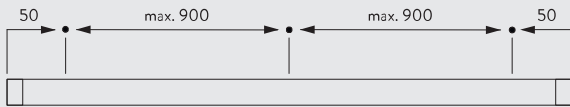

Fixing of cords / tapes

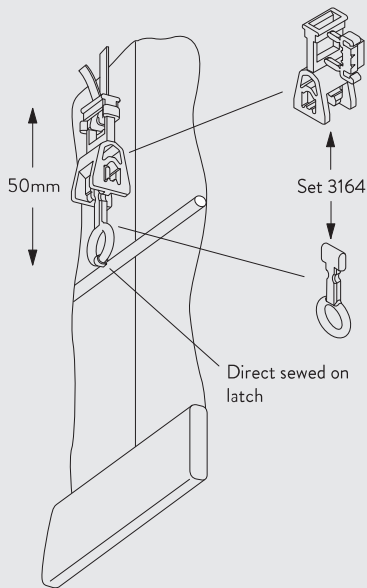

Using Breakaway Bottom Bar Set 3164

2305

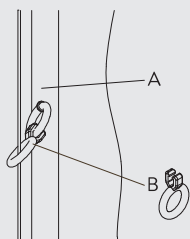

Soft fold:

- A: Breakaway Ring Tape Set 3166
- B: Set includes Child Safety Eyelet

Note: The Breakaway Ring Set is available without tape (part number 3165).

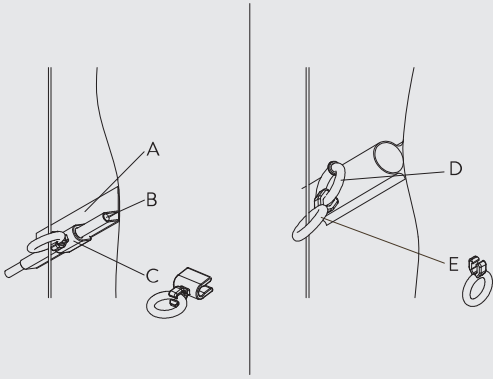

Hard fold:

A: Tape 2136

B: Steel rod 2135

C: Child Safety Eyelet (hard fold) 3069

D+E: Breakaway Set 3165

Fitting Options

Ceiling fitting with bracket SG 2302

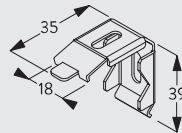
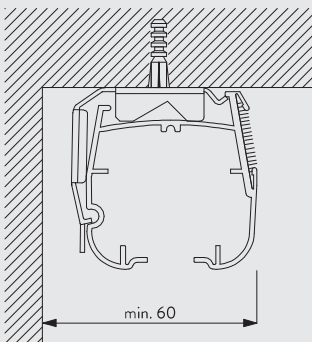

2302
Clip bracket

Ceiling fitting with bracket SG 2346

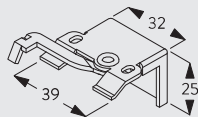
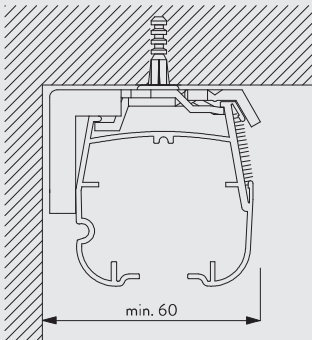

2346
Clamp bracket

Wall fitting with Smart Fix SG 11200-11205 and bracket SG 2302

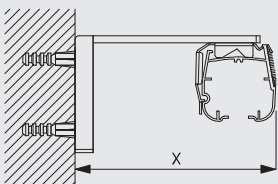

| | X (mm) |
|-------|---------|
| 11200 | 71-79 |
| 11201 | 91-99 |
| 11202 | 111-119 |
| 11203 | 131-139 |
| 11204 | 161-164 |
| 11205 | 211-219 |

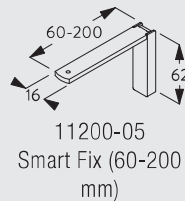

11200-05
Smart Fix (60-200
mm)

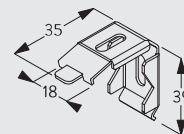

2302
Clip bracket

Screw SG 10395 (M4x6) needed.

2305

Wall fitting with Square Smart Fix SG 11210-11215 and bracket SG 2302

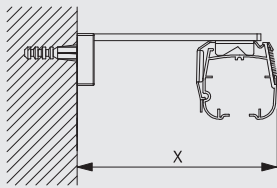

| | X (mm) |
|-------|---------|
| 11210 | 71-79 |
| 11211 | 91-99 |
| 11212 | 111-119 |
| 11213 | 131-139 |
| 11214 | 161-164 |
| 11215 | 211-219 |

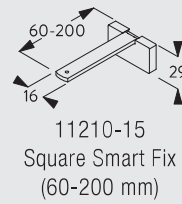

11210-15
Square Smart Fix
(60-200 mm)

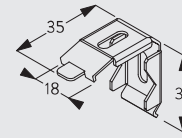

2302
Clip bracket

Screw SG 10395 (M4x6) needed.

Wall fitting with Universal Smart Fix SG 11154-11156 and bracket SG 2302

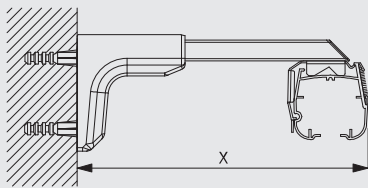

| | X (mm) |
|-------|---------|
| 11154 | 126-152 |
| 11155 | 156-182 |
| 11156 | 206-232 |

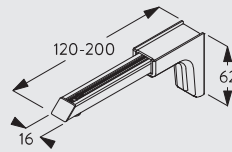

11154-56
Universal Smart Fix
(120-200 mm)

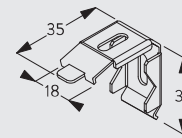

2302
Clip bracket

Screw SG 10492 (M4x8) needed.

Standard Accessories

2301 Profile with velcro insert



2302 Clip bracket



2307 Gear with breakaway set 1:4



2308 Spool with lift cord

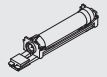

2309 Hex bar

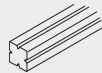

2311 Metal bead chain 4.5mm



2305

Optional Accessories

2004 Bottom bar



2006 Weight bar



2091 End cover



2135 Steel rod



2164 Ring tape



2310 Plastic bead chain



2312 Metal bead chain connector



2317 Gear without breakaway 1:4



















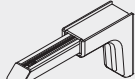
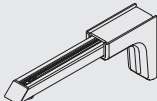
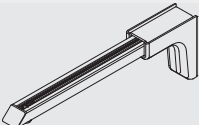

2319 Plastic bead chain connector

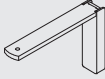
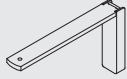

2346 Clamp bracket

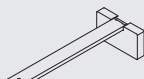
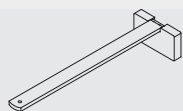

| | | | | | |
|-------|--|---|-------|--|---|
| 2347 | Plastic bead chain loops 100/125/150/175/200 cm |  | 2359 | Support |  |
| 3055 | Hook |  | 3069 | Breakaway rod cover (hard fold) |  |
| 3074 | Loop tape |  | 3164 | Breakaway bottom bar set (was 0877) |  |
| 3165 | Breakaway ring set for soft fold (was 0878) |  | 3166 | Breakaway ring tape for soft fold (was 0879) |  |
| 10395 | Pan head screw M4x6 |  | 10400 | Safety Cord Retainer |  |
| 10492 | Pan head screw M4x8 DIN 7985A |  | 11154 | Universal Smart Fix, 120 mm set |  |
| 11155 | Universal Smart Fix, 150 mm set |  | 11156 | Universal Smart Fix, 200 mm set |  |
| 11200 | Smart Fix, 60 mm set |  | 11201 | Smart Fix, 80 mm set |  |
| 11202 | Smart Fix, 100 mm set |  | 11203 | Smart Fix, 120 mm set |  |
| 11204 | Smart Fix, 150 mm set |  | 11205 | Smart Fix, 200 mm set |  |
| 11210 | Square Smart Fix, 60 mm set |  | 11211 | Square Smart Fix, 80 mm set |  |
| 11212 | Square Smart Fix, 100 mm set |  | 11213 | Square Smart Fix, 120 mm set |  |
| 11214 | Square Smart Fix, 150 mm set |  | 11215 | Square Smart Fix, 200 mm set |  |

2305

Useful Measurements

