

Chain Operated Roman Blind System

Silent Gliss® 2320

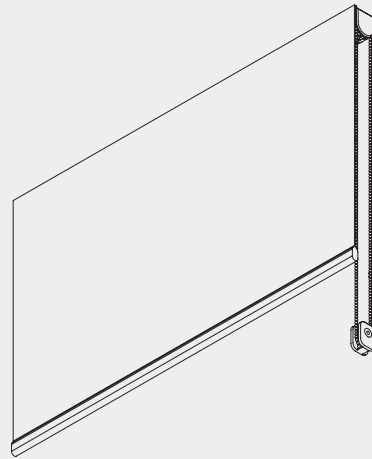

Product Information

- Chain operated Roman blind system for residential and contract applications
- Suitable for small to medium size applications
- New wind-up technique
- Very elegant appearance as all workings are hidden in a smart cassette
- Easy cleaning / maintenance through new cord release mechanism
- Extremely smooth and easy operation
- Blind stops at any required height without slippage
- Left or right hand operation
- Easy ceiling or wall fix to all surfaces
- Side guide option available
- Plastic or steel operating chain options available
- Compliant with Child Safety Legislation (EN13120)



2320

Supplied by

SG-S | Silent Gliss Spares
Silent Gliss Systems

www.sg-s.co.uk email: sales@sg-s.co.uk tel: 01395 232528

Profile, Bending and Specification Information

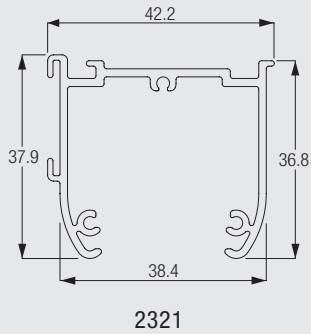

Cannot be bent.

Specification Guide - download from www.silentgliss.co.uk (password required).

Silent Gliss Roman/Austrian headrail system 2321 with bonded velcro 2221 insert in white. Fabric to be attached to profile using pile section velcro. Profiles to have endcovers 2337/2339. Blind to be lifted using cord 2216 attached to profile 8214 using cord release mechanism 2322/2323. Bead chain operation, left/right hand pull via gear drive 2335. Top/face fix using 2343 universal bracket at 80cm centres.

How to Measure

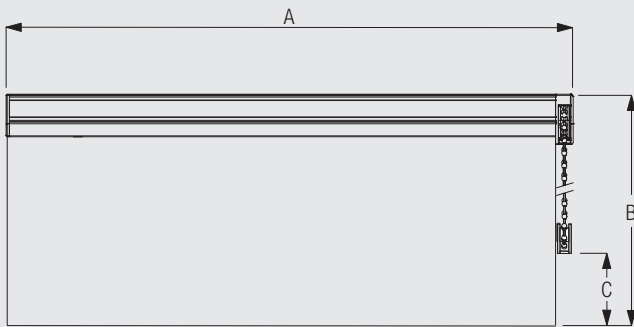

A: System length
B: System height



2320

System Dimensions



3.0m



3.0m



2.5kg

The system dimensions depend on the total fabric weight including the bottom weight bar.

For applications with a total weight of more than 2.5kg, refer to system 2330.

System Option Side guide

Side guides for stabilizing and sloping applications (up to 15°)

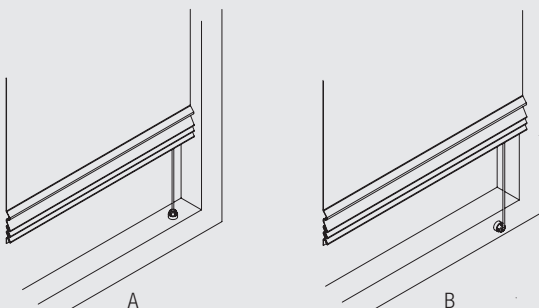

A: Fitting of side guides inside window frame
B: Fitting of side guides onto front of window frame

Fitting of side guides inside window frame or onto front of window frame. The system 2320 can be equipped with side-guide wires (0776) and can therefore also be used for sloping applications up to 15° inclination.

Child Safety Device

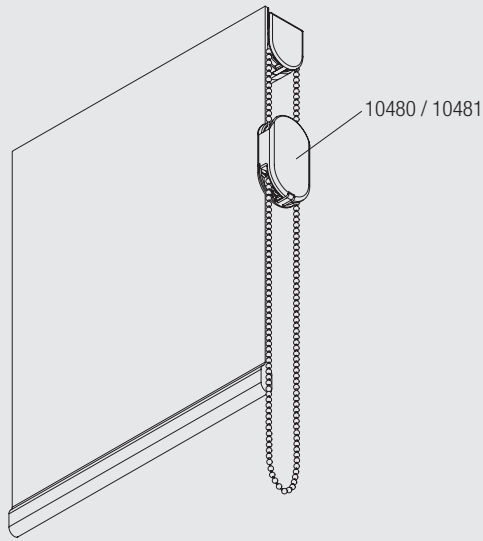

The Child Safety Device releases the chain should the pulling force exceed 6kg.

- SG10480: 4.5mm metal bead chain
- SG10481: 4.5mm plastic bead chain

Fitting and Sewing Information

WARNING

Young children can be strangled by loops in pullcords, chains, tapes and inner cords that operate the product. To avoid strangulation and entanglement, keep cords out of the reach of young children. Cords may become wrapped around a child's neck. Move beds, cots and furniture away from window covering cords. Do not tie cords together. Make sure cords do not twist to create a loop.

Bracket Positioning

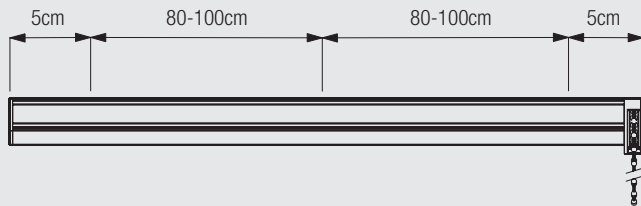

Please note: System has to be installed so chain with safety retainer 10400 ends at least 150 cm above floor!



Fixing of cords / tapes

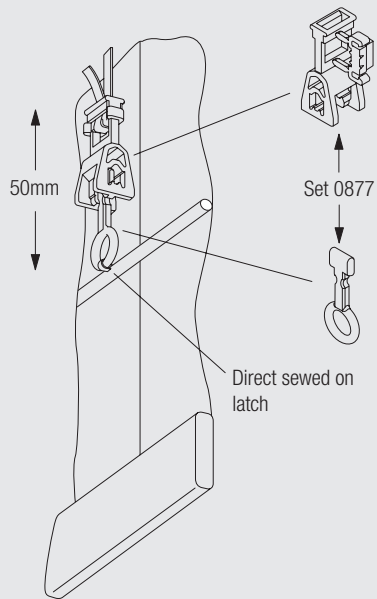

Using Breakaway Bottom Bar Set 0877

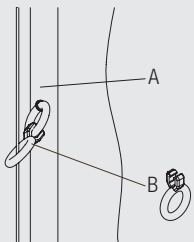

Soft fold:

- A: Breakaway Ring Tape Set 0879
- B: Set includes Child Safety Eyelet

Note: The Breakaway Ring Set is available without tape (part number 0878).

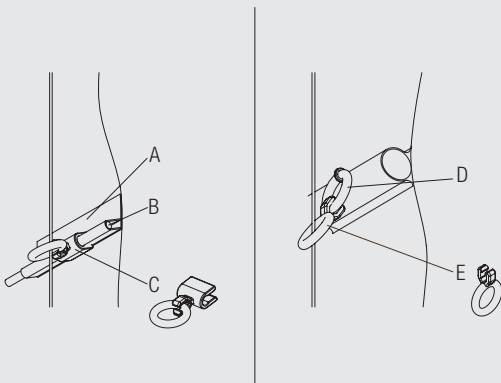

Hard fold:

- A: Tape 2136
- B: Steel rod 2135
- C: Child Safety Eyelet (hard fold) 3069

D+E: Breakaway Set 0878

Easy Washing / Easy Maintenance through Cord Release Mechanism

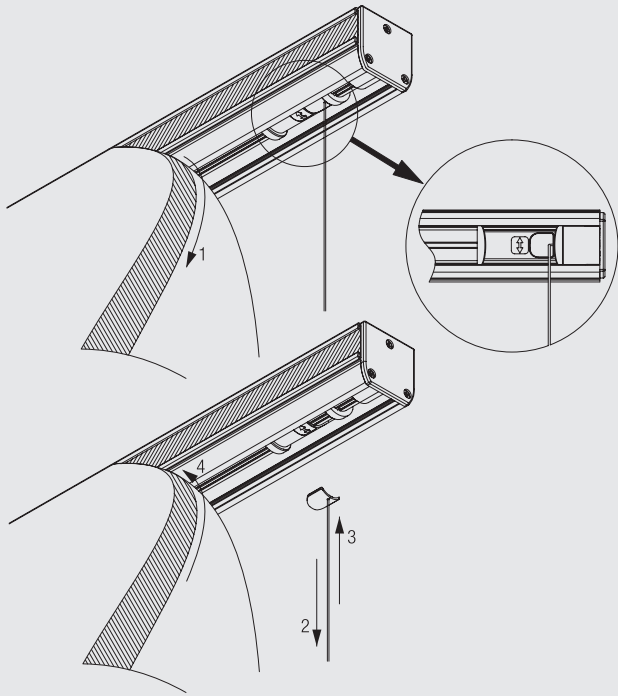

With the new developed cord release mechanism, taking down of the fabric becomes as easy as never

- 1: Remove fabric from the hook and loop tape when the blind is in down position of blind
- 2: Take off the pins by pulling on the lift cord
- 3: After washing, just press pins back to the shell
- 4: Refix fabric to the hook and loop tape on profile

Fitting Options

Ceiling fitting with bracket 2616

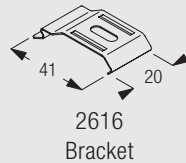
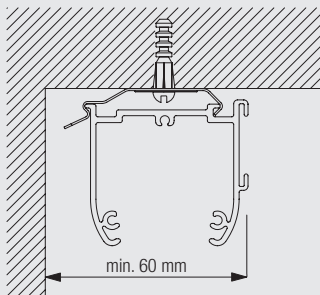

2320

Wall fitting with Smart Fix 11200-11205 and bracket 2616

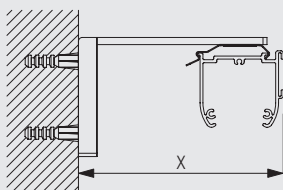

	X (mm)
11200	70-76
11201	90-96
11202	110-116
11206	130-136
11204	160-166
11205	210-216

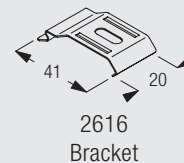
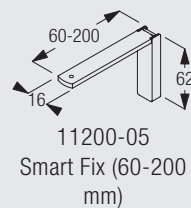

Brackets feature thread for screw SG 10395 (M4x6) for fixing bracket SG 2616.

Wall fitting with brackets 3134-39 and bracket 2616



Brackets feature thread for screw SG 10395 (M4x6) for fixing bracket SG 2616.

Wall fitting with Universal Smart Fix 11154-11156 and bracket 2616



Brackets feature thread for screw M4x8 for fixing the bracket 2616



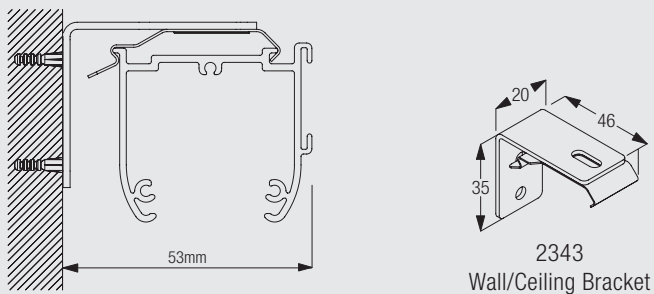





Wall/ceiling fitting with wall/ceiling bracket 2343



Do not use counter-sunk screws to fix the bracket 2616 on the ceiling.













The ceiling fixing with the bracket 2343 is according to the ceiling fixing with the bracket 2616.

Standard Accessories

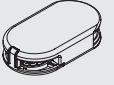
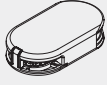
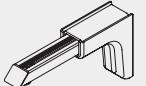
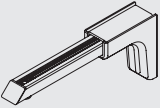
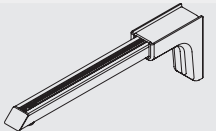
2216	Cord		2221	Hook and loop tape	
2321	Profile		2322	Pin	
2323	Shell		2327	Adapter	
2328	Adapter		2333	Wheel for plastic bead chain	

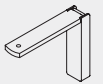
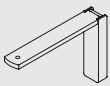
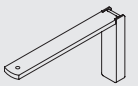
2334	White sleeve (for plastic bead chain)		2335	Drive Case 1:1	
2336	Support		2337	End Cover	
2339	Cover		2341	Wheel for steel bead chain	
2343	Wall/Ceiling Bracket		2344	Grey sleeve (for metal bead chain)	
2616	Bracket		2865	Bead chain connector	
2872	Operating chain		4845	Metal bead chain	
8214	Profile		10400	Safety Cord Retainer	

Optional Accessories

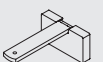
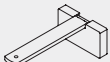
2004	Bottom Bar		2006	Bottom Bar	
2338	Wire Holder		8235	Wire base short	
8236	Wire base long		8237	Wire holder	
8249	Locking ring		10480	Child Safety Device - 4.5mm Metal Bead Chain	
10481	Child Safety Device - 4.5mm Plastic Bead Chain		11154	Universal Smart Fix, 120 mm set	
11155	Universal Smart Fix, 150 mm set		11156	Universal Smart Fix, 200 mm set	
11200	Smart Fix, 60 mm set		11201	Smart Fix, 80 mm set	
11202	Smart Fix, 100 mm set		11203	Smart Fix, 120 mm set	
11204	Smart Fix, 150 mm set		11205	Smart Fix, 200 mm set	
11210	Square Smart Fix, 60 mm set		11211	Square Smart Fix, 80 mm set	
11212	Square Smart Fix, 100 mm set		11213	Square Smart Fix, 120 mm set	



2320

11214 Square Smart Fix, 150 mm set

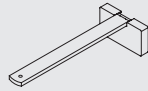

11215 Square Smart Fix, 200 mm set

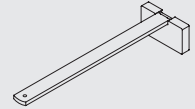

Sewing Accessories

2135 Steel rod



2136 Rod Tape



2539 Velcro pile



3069 Breakaway rod cover (hard fold)



3164 Breakaway bottom bar set (was 0877)

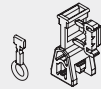

3165 Breakaway ring set for soft fold (was 0878)



3166 Breakaway ring tape for soft fold (was 0879)



Useful Measures

2004 Bottom Bar

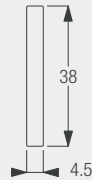

2006 Bottom Bar



10480 Child Safety Device - 4.5mm Metal Bead Chain

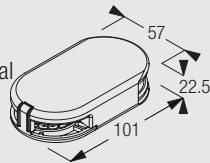

2320

Supplied by

SG-S | Silent Gliss Spares
Silent Gliss Systems

www.sg-s.co.uk email: sales@sg-s.co.uk tel: 01395 232528

Silent Gliss®

Supplied by



www.sg-s.co.uk email: sales@sg-s.co.uk tel: 01395 232528

www.silentgliss.co.uk

www.silentglissglobal.com

Silent Gliss Ltd
Pyramid Business Park
Poorhole Lane
Broadstairs
Kent
CT10 2PT
Great Britain

Tel: +44 (0) 1843 863571
Fax: +44 (0) 1843 864503
info@silentgliss.co.uk

Silent Gliss Global Ltd
Pyramid Business Park
Poorhole Lane
Broadstairs
Kent
CT10 2PT
Great Britain

Tel: +44 (0) 1843 874250
Fax: +44 (0) 1843 874457
info@silentglissglobal.com