

Chain Operated Roman Blind System

Silent Gliss® 2330

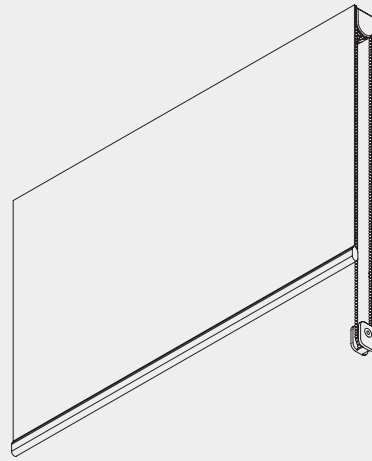

Product Information

- Chain operated (4:1 geared) roman blind system for residential and contract applications
- Suitable for small to medium size applications
- Elegant appearance
- Easy cleaning / maintenance through new cord release mechanism
- Extremely smooth and easy operation even in large dimensions
- Left or right hand operation
- The weight of the blind including the bottom weight and cross rods (if hard fold) should not exceed 4.5kg
- Easy ceiling or wall fix to all surfaces
- Side guide option available
- Plastic or steel operating chain options available
- Compliant with Child Safety Legislation (EN13120)



2330

Supplied by

SG-S | Silent Gliss Spares
Silent Gliss Systems

www.sg-s.co.uk email: sales@sg-s.co.uk tel: 01395 232528

Profile, Bending and Specification Information

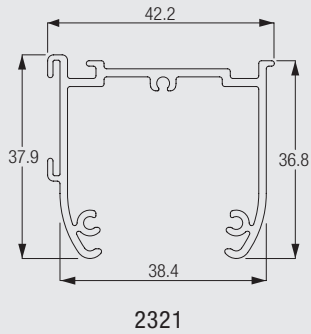

Cannot be bent.

Specification Guide - download from www.silentgliss.co.uk (password required).

Silent Gliss Roman/Austrian headrail system 2321 with bonded velcro 2221 insert in white. Fabric to be attached to profile using pile section velcro. Profiles to have endcovers 2337/2339. Blind to be lifted using cord 2216 attached to profile 8214 using cord release mechanism 2322/2323. Bead chain operation, left/right hand pull via gear drive 2326. Top/face fix using 2343 universal bracket at 80cm centres.

How to Measure

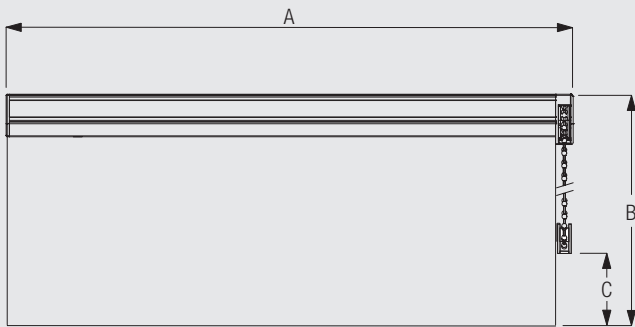

A: System length
B: System height



2330

System Dimensions



3.0m



3.0m



4.5kg

The system dimensions depend on the total fabric weight including the bottom weight bar.

A gear drive (2326) will be built in. This will slow down the up/down movement of the blind (ratio 4:1), but ensures a comfortable operation for the user.

System Option Side guide

Side guides for stabilizing and sloping applications (up to 15°)

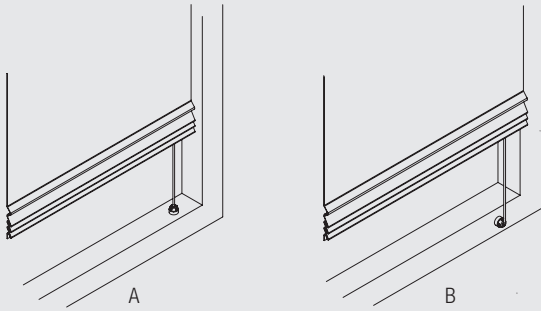

- A: Fitting of side guides inside window frame
- B: Fitting of side guides onto front of window frame

Fitting of side guides inside window frame or onto front of window frame. The system 2330 can be equipped with side-guide wires (0776) and can therefore also be used for sloping applications up to 15° inclination.

Child Safety Device

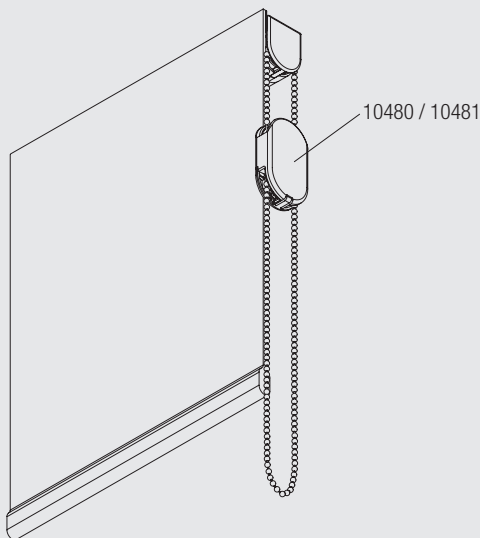

The Silent Gliss Child Safety Device releases the chain should the pulling force exceed 6kg.

- 10480: Metal bead chain 4.5mm
- 10481: Plastic bead chain 4.5mm



2330

Fitting and Sewing Information

WARNING

Young children can be strangled by loops in pullcords, chains, tapes and inner cords that operate the product. To avoid strangulation and entanglement, keep cords out of the reach of young children. Cords may become wrapped around a child's neck. Move beds, cots and furniture away from window covering cords. Do not tie cords together. Make sure cords do not twist to create a loop.

Bracket Positioning

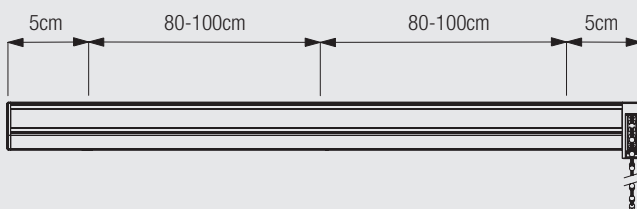

Please note: System has to be installed so chain with safety retainer 10400 ends at least 150 cm above floor!

Fixing of cords / tapes

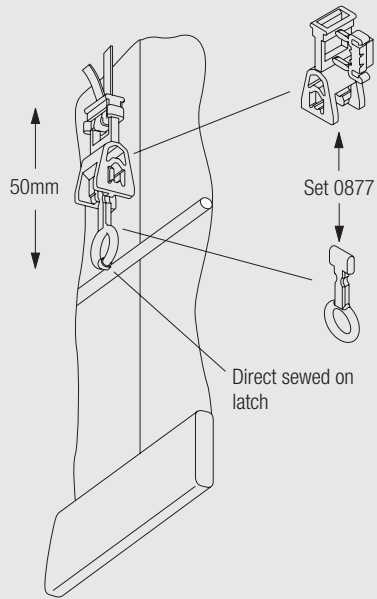

Using Breakaway Bottom Ring Set 0877

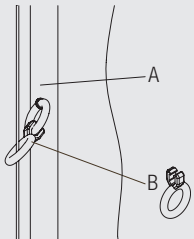

Soft fold:

- A: Breakaway Ring Tape Set 0879
- B: Set includes Child Safety Eyelet

Note: The Breakaway Ring Set is available without tape (part number 0878).



2330

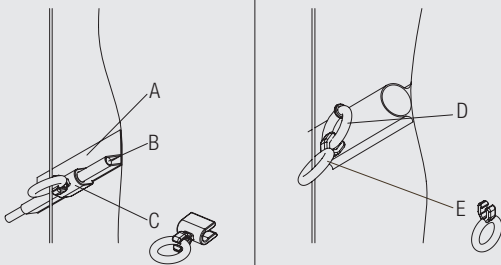

Hard fold:

- A: Tape 2136
- B: Steel rod 2135
- C: Child Safety Eyelet (hard fold) 3069

D+E: Breakaway Ring Set 0878

Easy Washing / Easy Maintenance through Cord Release Mechanism

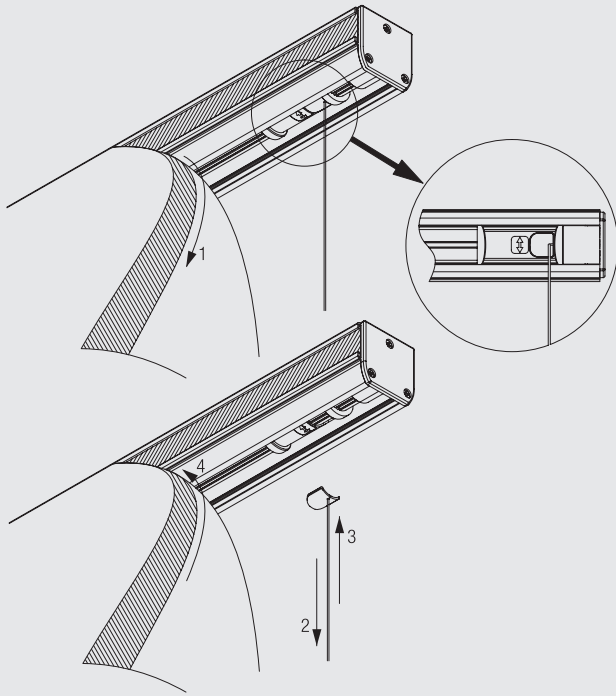

With the new developed cord release mechanism, taking down of the fabric becomes as easy as never

- 1: Remove fabric from the hook and loop tape in down position of blind
- 2: Take off the pins by pulling on the lift cord
- 3: After washing, just press pins back to the shell
- 4: Refix fabric to the hook and loop tape on profile

Fitting Options

Ceiling fitting with bracket 2616

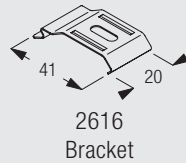
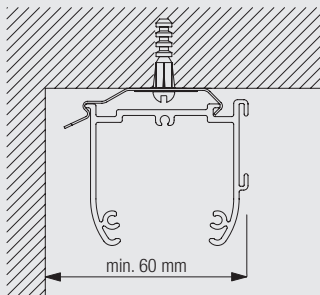

2330

Wall fitting with Smart Fix 11200-11205 and bracket 2616

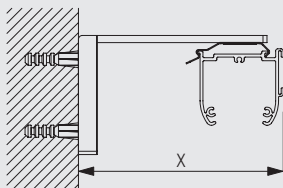

	X (mm)
11200	70-76
11201	90-96
11202	110-116
11203	130-136
11204	160-166
11205	210-216

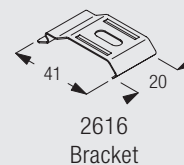
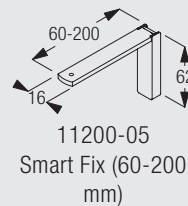

Brackets feature thread for screw SG 10395 (M4x6) for fixing bracket SG 2616.

Wall fitting with Square Smart Fix 11210-11215 and bracket 2616

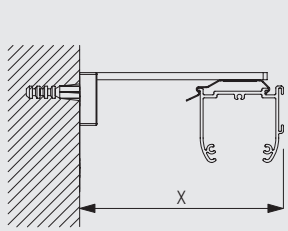

	X (mm)
11210	70-76
12111	90-96
11212	110-116
11213	130-136
11214	160-166
11215	210-216

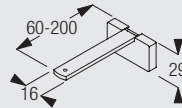

11210-15
Square Smart Fix
(60-200 mm)

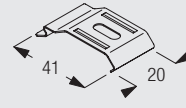

2616
Bracket

Brackets feature thread for screw SG 10395 (M4x6) for fixing bracket SG 2616.

Wall fitting with Universal Smart Fix 11154-11156 and bracket 2616

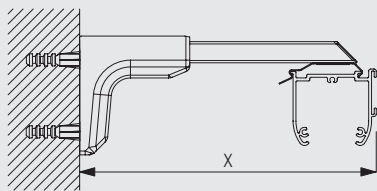

	X (mm)
11154	126-154
11155	156-184
11156	206-234

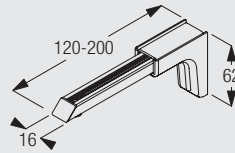

11154-56
Universal Smart Fix
(120-200 mm)

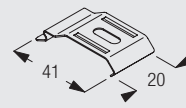

2616
Bracket

Brackets feature thread for screw SG 10492 (M4x8) for fixing bracket SG 2616.

Wall/ceiling fitting with wall/ceiling bracket 2343

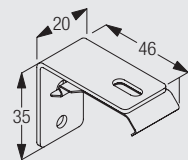
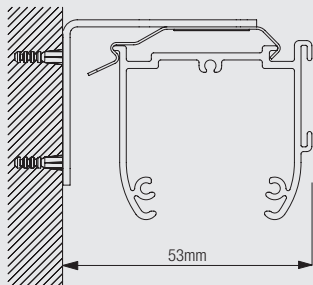

2343
Wall/Ceiling Bracket

Do not use counter-sunk screws to fix the bracket 2616 on the ceiling.

The ceiling fixing with the bracket 2343 is according to the ceiling fixing with the bracket 2616.

Standard Accessories

2046 Driving pulley



2047 Driving sleeve



2216 Cord



2221 Hook and loop tape



2321 Profile



2322 Pin



2323 Shell















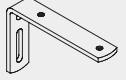
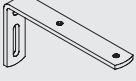
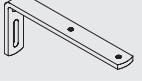
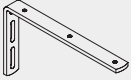

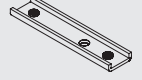
2325 Cover

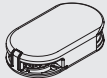

2326	Drive Case 4:1		2327	Adapter	
2329	Adapter		2336	Support	
2337	End Cover		2343	Wall/Ceiling Bracket	
2616	Bracket		2865	Bead chain connector	
2872	Operating chain		4845	Metal bead chain	
8214	Profile		10400	Safety Cord Retainer	

Optional Accessories

2004	Bottom Bar		2006	Bottom Bar	
2338	Wire Holder		3133	Bracket cover (60mm)	
3134	Extension bracket (60mm)		3135	Extension bracket (80mm)	
3136	Extension bracket (100mm)		3137	Extension bracket (120mm)	
3138	Extension bracket (150mm)		3139	Extension bracket (200mm)	
3271	Adjustable bracket base		3272	Adjustable bracket arm (69mm)	
3273	Adjustable bracket arm (92mm)		3274	Adjustable bracket arm (122mm)	
8235	Wire base short		8236	Wire base long	
8237	Wire holder		10480	Child Safety Device - 4.5mm Metal Bead Chain	
10481	Child Safety Device - 4.5mm Plastic Bead Chain		3133L	Extended bracket cover for 3137/8/9	



2330

Sewing Accessories

2135	Steel rod		2136	Rod Tape	
------	-----------	---	------	----------	---

2539 Velcro pile



3069 Breakaway rod cover (hard fold)



3164 Breakaway bottom bar set (was 0877)



3165 Breakaway ring set for soft fold (was 0878)



3166 Breakaway ring tape for soft fold (was 0879)



Useful Measures

2004 Bottom Bar

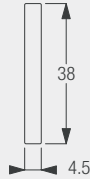

2006 Bottom Bar

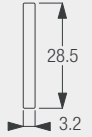

10480 Child Safety Device - 4.5mm Metal Bead Chain

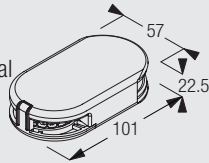

2330

Supplied by

SG-S | Silent Gliss Spares
Silent Gliss Systems

www.sg-s.co.uk email: sales@sg-s.co.uk tel: 01395 232528

Silent Gliss®

Supplied by



www.sg-s.co.uk email: sales@sg-s.co.uk tel: 01395 232528

www.silentgliss.co.uk

www.silentglissglobal.com

Silent Gliss Ltd
Pyramid Business Park
Poorhole Lane
Broadstairs
Kent
CT10 2PT
Great Britain

Tel: +44 (0) 1843 863571
Fax: +44 (0) 1843 864503
info@silentgliss.co.uk

Silent Gliss Global Ltd
Pyramid Business Park
Poorhole Lane
Broadstairs
Kent
CT10 2PT
Great Britain

Tel: +44 (0) 1843 874250
Fax: +44 (0) 1843 874457
info@silentglissglobal.com