

Panel Glide System

Silent Gliss® 2500 Panel Glide

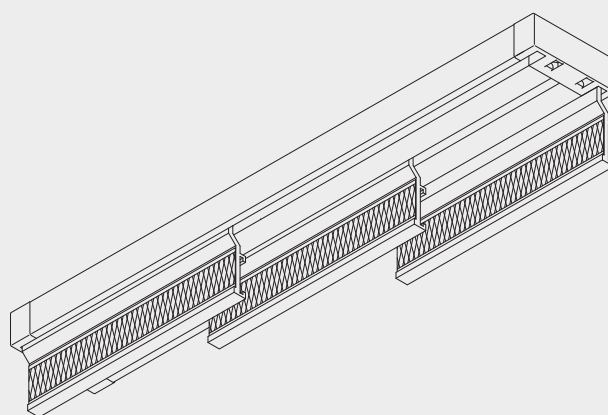

Product Information

- A unique system of sliding panels for use as a window treatment, wall dressing or as a room divider.
- Gliders allow for silent operation to take virtually any fabric including customers own material. Recommended width of fabric 50cm-100cm approx but carrier can be cut to exact desired width.
- Standard profile length 6m. White only. Silver aluminium carriers with gliders and bonded Velcro tape.
- Single, centre or pair stack or unconnected panels (individual movement).
- Operating methods: hand, cord or electrically operated.
- Cannot be bent.



2500

Profile, Bending and Specification Information

2 Channel profile

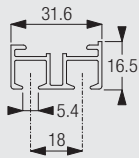

6003



Cannot be bent

3 Channel profile

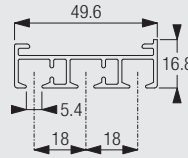

6058



Cannot be bent

4 Channel profile

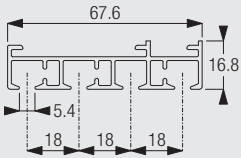

6054



Cannot be bent

5 Channel profile

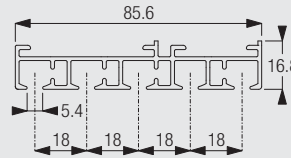

6055



Cannot be bent

Each system is built up from the four different profiles available. Basically for a single stack system (i.e. where all panels stack together at one side or in the middle) one channel is needed for each panel. For pair stacks, one channel is needed for every two panels, plus one extra for the system.

Cord operated systems must incorporate profile 6058, 6054 or 6055.

Normally delivered ready assembled.

Specification Guide - download from the Silent Gliss Extranet

Silent Gliss 2500 Panel Glide system complete and assembled comprising tracks 6003/6058/6054/6055 as necessary with carriers 2511, bottom weight 2066 and all necessary fittings to provide a fully working panel systemm o/a drop arranged to stack right hand single/left hand single/pair/centre stack, cord/hand/electrically operated with fabric Detail specification to be agreed between architect/interior designer/contractor and Silent Gliss Ltd.



2500

How to Measure

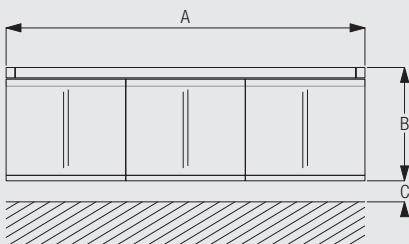

- A: system width
- B: system drop
- C: 15mm recommended clearance
- B + C = Total floor to ceiling drop

Dimensions of Panels

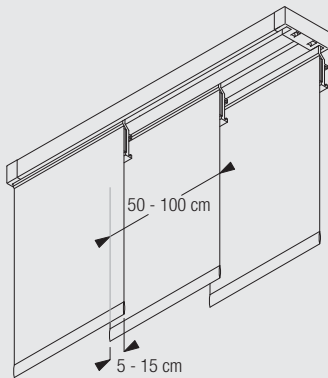

Panels are suspended from carrier 2511 in the profile channel (bonded with Velcro tape). The width of the fabric panel can be varied but is normally between 50-100cm for flexibility. An overlap of at least 10cm, preferably 15cm is needed.

Panels should not exceed 2kg per metre including bottom bars.

Note: the minimum stack size on a single stack will be the width of one panel. For pair stack it will be width of one panel on each side.

System Dimensions



unlimited when
hand operated with
unconnected panels



4m



6sqm per panel



2kg per panel metre
(incl. weight bar)

The system dimensions possible depend mainly on the operation method and the fabric weight. For hand operated with unconnected panels the system length is unlimited. However, hand drawn with draw rod and connected panels or cord operated systems should not exceed a total system length of 6m. The maximum drop of the system should not exceed 4m.

Operating Methods and Stacking Variations

Hand operated (unconnected panels)

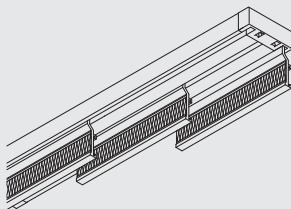

Draw rods optional.



2500

Hand operated by draw rod (connected panels)

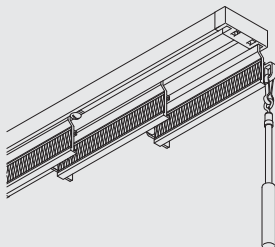

Cord operated (connected panels)

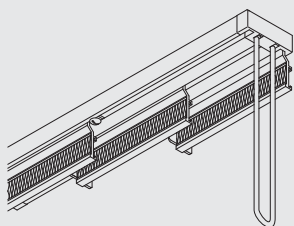

Electrically operated (with System 5400)

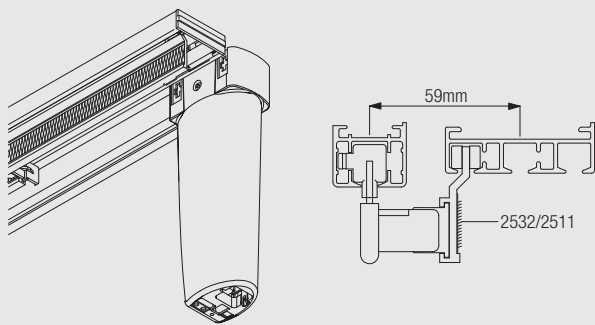

To motorise the Silent Gliss 2500 Panel system it is necessary to combine it with the Silent Gliss 5400 Electric curtain track system. Please refer to the Electric Tracks section of this catalogue.

Distance between panel profiles and electric curtain track profile is 11mm.

Single stack right or left (open / closed)



Centre stack (open / closed)



Pair stack (open / closed)

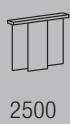

2500

Fitting Information

Ceiling fixing with clamp 3003/3004

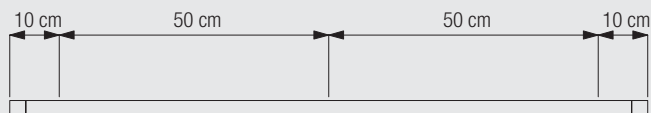

Higher edge of profile to the room side/clamp arm to the window.

Clamp 3004 for use with profile 6003. Clamp 3003 for use with profiles 6054, 6055, 6058, (for recess ceiling fix use brackets 2562/2521).

Numerous profile combinations are possible - please see the application chart.
Important: distance between all profiles = 4mm.

Carrier fitting with glider 2549

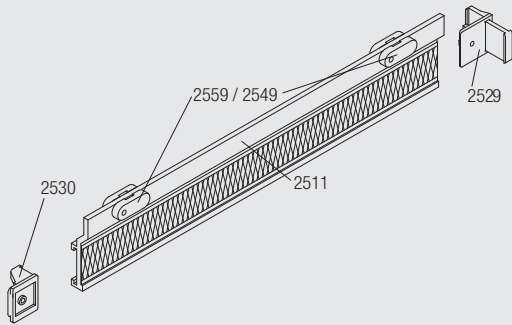

Glidors 2559/2549 are clicked on to aluminium carrier 2511.

Fabric fitting to carrier

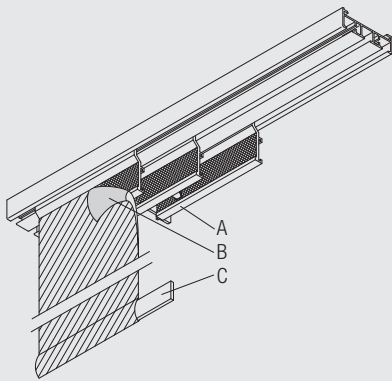

By using a Velcro tape the panels are easily removed for cleaning or to change decor .
 A: Carrier
 B: Velcro tape
 C: Bottom weight bar

Fitting Options

Ceiling fix with clamp 3003/3004

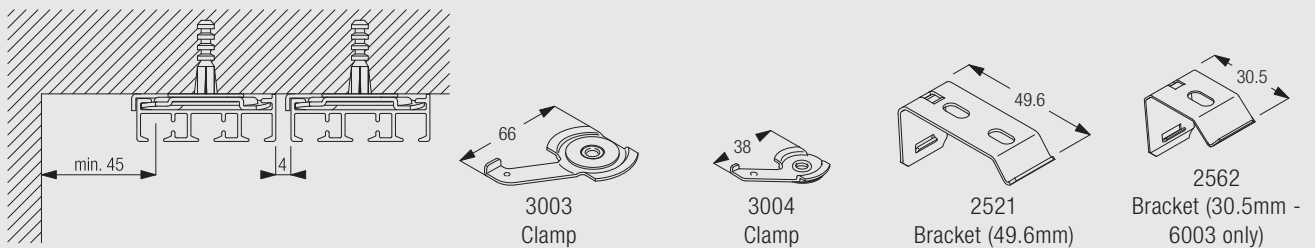

Clamp 3004 to be used for profile 6003 and clamp 3003 for profile 6054, 6055, 6058.
 The distance between profiles is 4mm.
 For recess ceiling fix, use brackets 2562 and 2521.



2500

Wall fix with brackets 3135-39 and brackets 2521/2562

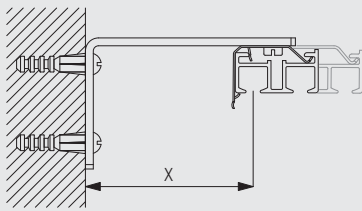

	x (mm)	W (mm)	Y (mm)	Z (mm)
3135	61	-	50	50
3136	81	-	50	50
3137	101	-	80	50
3138	121	60	80	60
3139	181	85	80	85

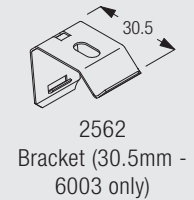
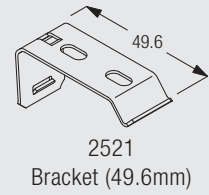
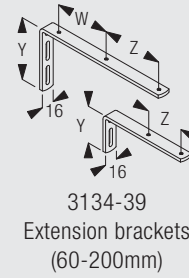

Bracket 2562 to be used for 2 channel profile 6003; bracket 2521 to be used for multiple channel profiles 6058, 6054 and 6055. Brackets 3135-9 are threaded for screw 6748 for fixing the bracket.

Standard Accessories

2006 Weight bar



2501 Cord guide for 6055

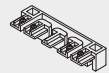

2502 Cord guide for 6058



2505 Cord guide for 6054

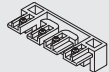

2511 Carrier (aluminium)



2518 Endcover for 6058



2519 Endcover for 6054



2520 Eyelet



2529 Angle



2530 Angle



2533 Endcover for 6055



2535 Endcover for 6003



2539 Velcro pile



2549 Glider (2 required)



2558 Pilot runner



3003 Clamp

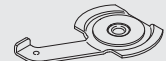

3004 Clamp



3090 Cord (ø 3.5mm)



4092 Plastic draw rod (4092S Aluminium)

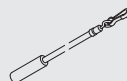

6003 Profile



6007 Endstop



6054 Profile



2500

6055 Profile 

6058 Profile 

1148C Countersunk screw

Optional Accessories

2521 Bracket (49.6mm)



2562 Bracket (30.5mm - 6003 only)



3008 Connecting bridge



3133 Bracket cover (60mm)



3135 Extension bracket (80mm)

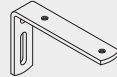

3136 Extension bracket (100mm)



3137 Extension bracket (120mm)

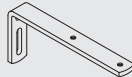

3138 Extension bracket (150mm)

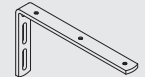

3139 Extension bracket (200mm)

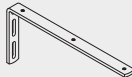

6024 Connecting bridge

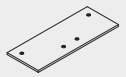

6748 Cheese head machine screw (M4)

Useful Information

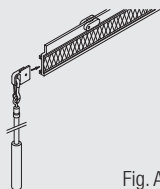

Fig. A

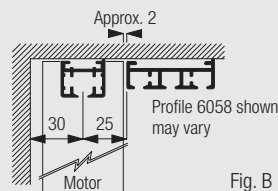

Fig. B

A: Pilot runner eyelet

B: Motor/track positioning for fixing an electrically operated System 2500.

Useful Measurements

2006 Weight bar

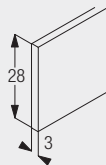

Overview Features Motors and Controls

The system 2500 can be electrically operated by combining it with the Silent Gliss 5400 System. Please refer for all motor and control features to System 5400 within the product group "Electrically Operated Curtain Track Systems".

