

## Dim-Out Blind System

# Silent Gliss® 4510

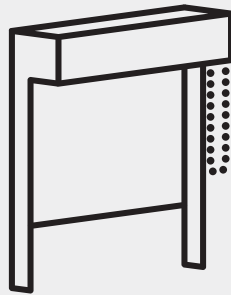

### Product Information

- Technically advanced chain-operated blind with over 20 years experience in dim-out blinds
- Choice of three cassette headboxes depending on drop and thickness of fabric, ensuring smallest dimensions of system possible commensurate with efficient operation
- Choice of two side profiles depending on installation requirements
- Standard is inside recess profile using adjustable side profiles to allow for variations in width of framework. Optional outside recess profile also available
- For situations where there may be excessive air movement use system 4540/4550 with heavy duty side profile 4516
- Fabrics are contained within the side profiles by rivets
- Black or white frame as standard; silver and colours are available to special quote. Plastic components are black or white in all cases
- Choice of FR blackout fabrics
- Delivered ready-assembled made-to-measure
- Can also be operated in inclined or horizontal positions up to 30° from vertical



4510

## Profile and Bending Information

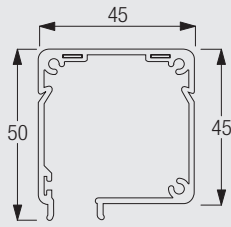

4501



Cannot be bent.

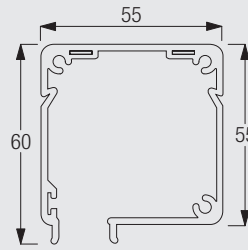

4502



Cannot be bent.

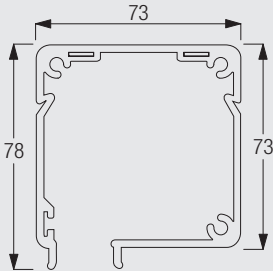

4503



Cannot be bent.

The choice of fabric may influence the size of headbox/profile to be used.  
Thicker fabrics may require the use of profile 4502 (55mm) or 4503 (73mm).

## How To Measure

Measurements for Silent Gliss Dim-Out Systems should be undertaken by a fully trained dim-out specialist.



4510

## System Dimensions



4501 140cm  
4502 180cm  
4503 210cm



4501 50cm  
4502 60cm  
4503 30cm



4501 120cm  
4502 180cm  
4503 240cm

## Fitting Information

Adjustable side profiles 4511 and 4512 for inside recess

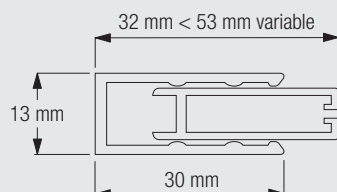

Side profiles 4513 and 4514 for outside recess

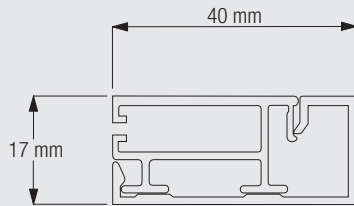

Fitting Options

Top fix with bracket 4538, 4539 or 4541

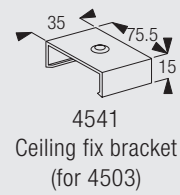
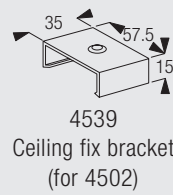
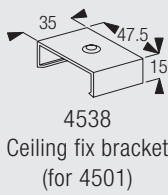
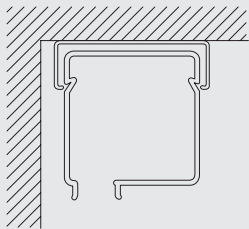

Face fix (wall) with bracket 4531

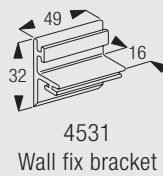
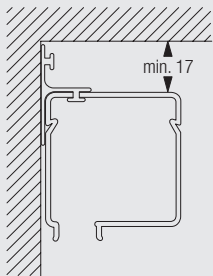

Face fix outside recess with bracket 4531

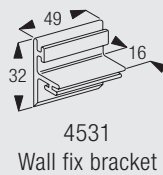
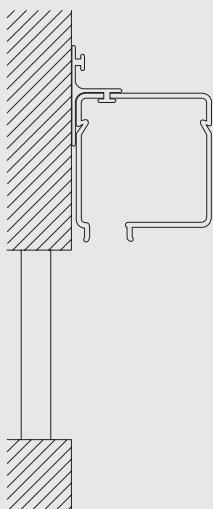

Also includes 4513/4514 as a bottom guide.







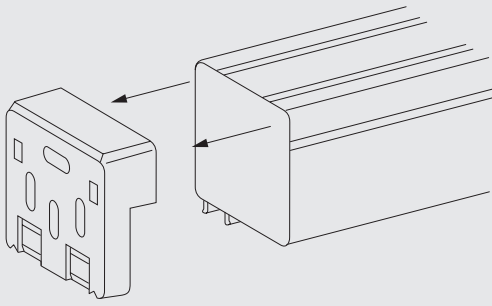







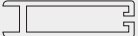

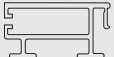

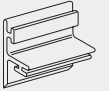
4510

End fix with bracket 4526/4527/4528

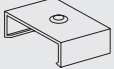

Standard Accessories

4501	Profile		4502	Profile	
4503	Profile		4511	Side Profile (used with 4512 profile)	
4512	Side Profile (used with 4511 profile)		4513	Side Profile (used with 4514 profile)	
4514	Side Profile (used with 4513 profile)		4526	Plastic end bracket (for 4501)	
4527	Plastic end bracket (for 4502)		4531	Wall fix bracket	
4534	Right inside recess bracket (for 4502)		4535	Left inside recess bracket (for 4502)	
4536	Right inside recess bracket (for 4503)		4537	Left inside recess bracket (for 4503)	
4538	Ceiling fix bracket (for 4501)		4539	Ceiling fix bracket (for 4502)	
4541	Ceiling fix bracket (for 4503)		10400	Safety Cord Retainer	



4510