

## Motorised Dim-Out Blind System

# Silent Gliss® 4770 Medium

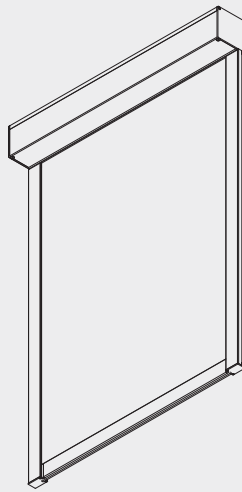

### Product Information

- Technically advanced motorised dim-out blind system.
- Up to 2.2m wide, 2.4m high or 5.3 m<sup>2</sup> with a maximum weight 3.7kg.
- Easy click-in side profiles.
- Inside or outside recess fitting.
- Supplied powder coated black or white.
- Fabrics are 'zipped' into the side profiles.
- Delivered ready-assembled made-to-measure.
- Suitable for inclined positions up to 15° from vertical.
- Applicable with Radio Remote Control Systems and Silent Gliss Move app.
- Optional Smart motor to allow integration and control by most major home control systems

4770

## Profile and Bending Information

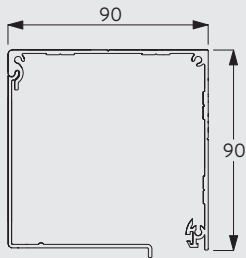

10996-7

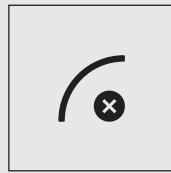

Cannot be bent

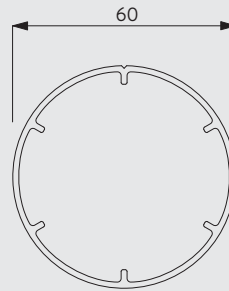

11037



Cannot be bent

### Specification Text

#### With Series 20 Motors

Silent Gliss 4770 Electrically Operated Dim-Out Roller Blind System with SG Series 20 motors for blinds up to 2.2m wide by 2.4m drop, max 5.3 sq.m. Supplied made to measure and complete comprising aluminium cassette headbox 10996-7/90mm and frame finished in white or black as standard. Supplied with easy click-in side profiles 11001/11002 and fabrics are 'zipped' into the side profiles. Can be operated at up to a 15° from vertical. Integral 230v 50 Hz powered motor. Operation by mains switch (not supplied) or mains switching by third party control system or / SG 0450 remote control system (wireless controls at extra cost). All wiring to be strictly in accordance with Silent Gliss wiring diagrams. Fabric to be chosen from the Silent Gliss fabric range, Price Group 1R / 2R / 3R.

#### With Series 40 Motors

Silent Gliss 4770 Electrically Operated Dim-Out Roller Blind System with SG Series 40 motors for blinds up to 2.2m wide by 2.4m drop, max 5.3 sq.m. Supplied made to measure and complete comprising aluminium cassette headbox 10996-7/90mm and frame finished in white or black as standard. Supplied with easy click-in side profiles 11001/11002 and fabrics are 'zipped' into the side profiles. Can be operated at up to a 15° from vertical. Integral 24V DC\* /100-240 V AC 50/60Hz motor. (\*24V DC transformer not included). Operation by dry contact switching either from fixed switch (not supplied) or third party control system and / or Silent Gliss 9940 radio control system via integrated receiver. (9940 control components supplied at additional cost). All wiring to be strictly in accordance with Silent Gliss wiring diagrams. Fabric to be chosen from the Silent Gliss fabric range, Price Group 1R / 2R / 3R

#### With Smart Motors

Silent Gliss 4770 Electrically Operated Dim-Out Roller Blind System with Smart by Silent Gliss motors for blinds up to 2.2m wide by 2.4m drop, max 5.3 sq.m. Supplied made to measure and complete comprising aluminium cassette headbox 10996-7/90mm and frame finished in white or black as standard. Supplied with easy click-in side profiles 11001/11002 and fabrics are 'zipped' into the side profiles. Can be operated at up to a 15° from vertical. Integral 24V DC powered Smart by Silent Gliss motor left / right side. Operation only via Silent Gliss Smart Gateway and associated components in conjunction with compatible third-party control systems. All wiring to be strictly in accordance with Silent Gliss wiring diagrams. Fabric to be chosen from the Silent Gliss fabric range, Price Group 1R / 2R / 3R.

4770

## How To Measure

### Inside fitting

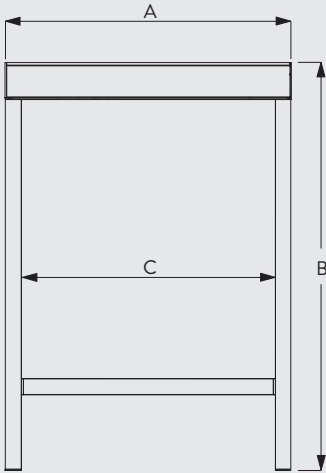

A: System width  
B: System drop  
C: Fabric width

### Face fitting

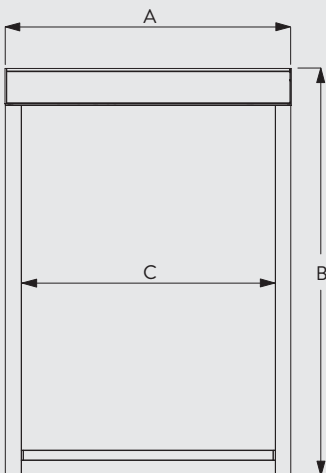

A: System width  
B: System drop  
C: Fabric width

4770

## System Dimensions

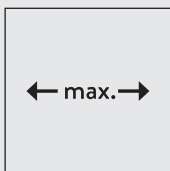

2.2m  
See below:



See below:

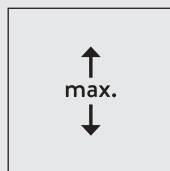

2.4m

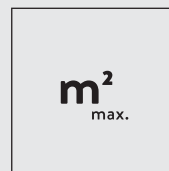

5.3m<sup>2</sup>



3.7kg

Maximum system width/drop also depends on the fabric type.<br>

Minimum system width:

- Series 20 / Series 40 / Smart: 65cm
- Series 40 mains: 82cm

## System Options

### Radio Remote Control System Silent Gliss 9940

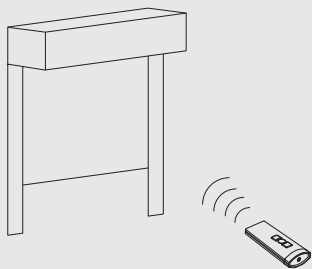

The Silent Gliss motors 10423 and 10523 feature an integrated radio receiver. Combined with the Radio Remote Control System Silent Gliss 9940, this system offers maximum comfort with minimum wiring.

The Silent Gliss motors 10422 and 10522 can be used with Radio Control System 0450 but will use an external radio receiver.

For further details, please refer to catalogue section "Motors & Controls".

### Silent Gliss Move App

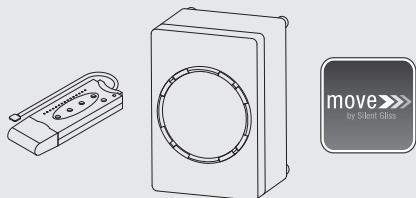

Operation of system with Silent Gliss Move app using a smartphone, tablet or desktop.

Whether at home or on the road, this reliable and intuitive app allows to program automatic opening and closing times. Furthermore, automatic sunrise and sunset time programming and groups and moods are possible.

The app is available for Android, IOS and Windows and can be downloaded in the respective app stores. Additionally, the Move Server Set Silent Gliss 9960 is required.

For further details, please refer to product group "Motors & Controls".

### Smart by Silent Gliss

Silent Gliss offer Smart motor option 11251 which allows this dimout system to be integrated into, and controlled by most major home control systems.

## Fitting Information

### Positioning of drill holes

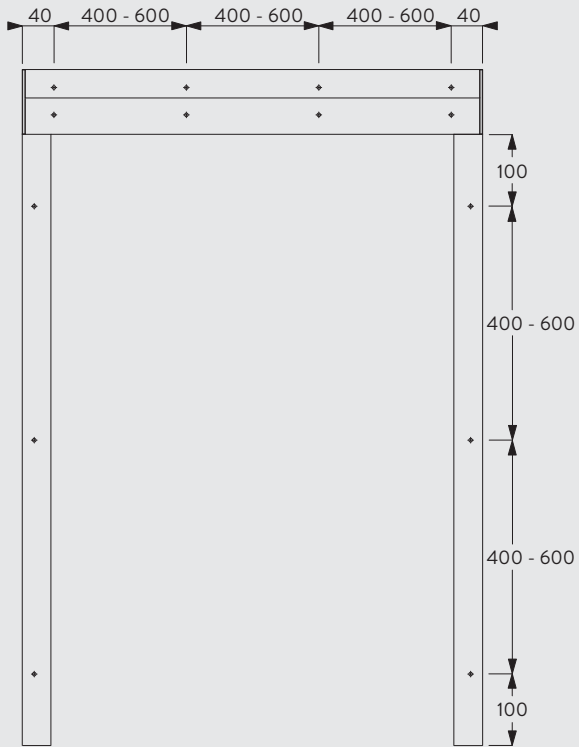

### Side profiles 11001 and 11002

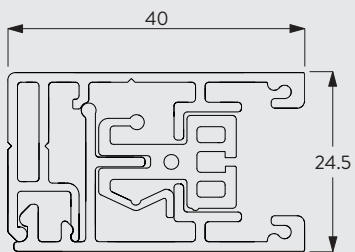

Drawing includes zip profile.

4770

## Fitting Options

### Ceiling fitting with direct mounting

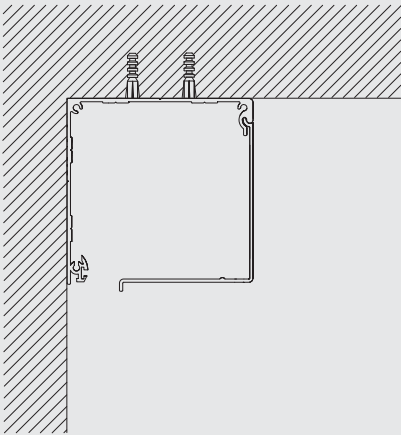

### Wall fitting with direct mounting

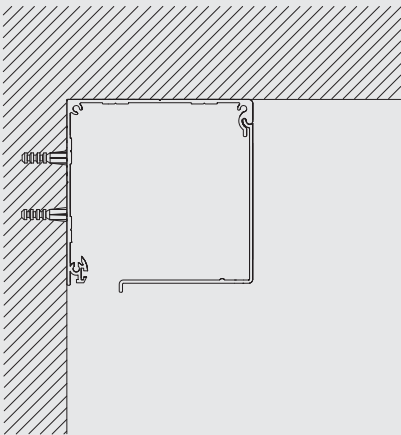

### Recess fitting with direct mounting

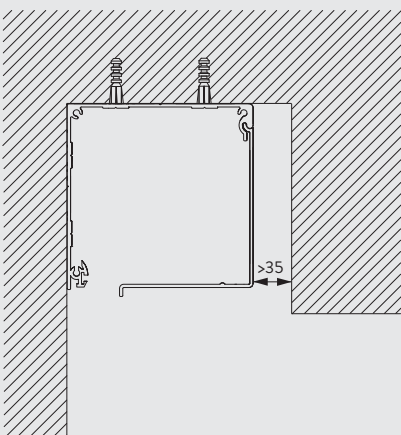

4770

## Standard Accessories

10522 Motor 20-Series, 230V

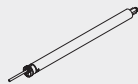

10961 Zip profile









Supplied by

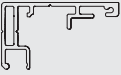



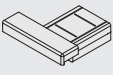





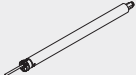

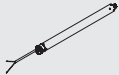

**SG-S** | Silent Gliss Spares  
Silent Gliss Systems

www.sg-s.co.uk email: sales@sg-s.co.uk tel: 01395 232528

Silent Gliss®

10993	Bottom weight		11001	Side guide case	
11002	Side guide cover		11011	Clip for support	
11013	Clip for motor		11024	Zip guide	
11026	Cover left for side guide		11027	Cover right for side guide	
11028	Bottom weight guide left		11029	Bottom weight guide right	
11030	Bottom weight cover		11037	Profile tube, 60 mm	
10996-7	Box case and cover, 90 mm				

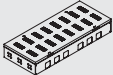
## Optional Accessories

10422	Motor 20-Series, 120 V		10520	Motor 20-Series, 120 V	
11241	Motor 100-240V AC, 40-Series S 3/32, radio receiver		11244	Motor 24V DC, 40-Series S 3/32, radio receiver	
11251	Smart motor 24V DC		11260	Smart controller gateway Cedia	
11261	Smart controller gateway KNX		11262	Smart expansion unit	
11263	Power supply 24V DC, 2 Ampere DIN Rail		11264	Power supply 24V DC, 3.8 Ampere DIN Rail	
11265	Power supply 24V DC, 5 Ampere DIN Rail		11266	Power supply 24V DC, 10 Ampere DIN Rail	
11281	Cabinet for 8 systems		11282	Cabinet for 24 systems	
11283	Cabinet for 56 systems		11325	Smart plug 6-pin, MC 1.5/6 ST-3.81	

4770

## Useful Measures

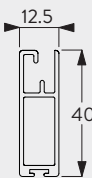
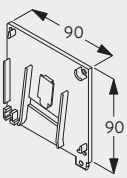
10993	Bottom weight		11006	Side cover left for box, 90 mm	
-------	---------------	---	-------	--------------------------------	---

## Motor & Controls

### Motor Silent Gliss 10422 (20 Series)

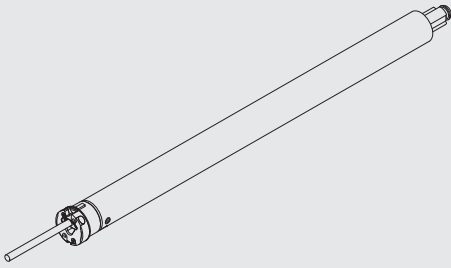

- Motor length: 545mm
- Voltage: 120 V AC
- Torque: 3 Nm
- Speed: 30 rpm
- Frequency: 50 Hz
- Power: 135 W
- Current: 0.60 A
- Thermal Overload Protection
- CE Standard
- Cable pluggable
- Max. Weight Capacity: 7.5 kg

### Motor Silent Gliss 10520 (120 V)

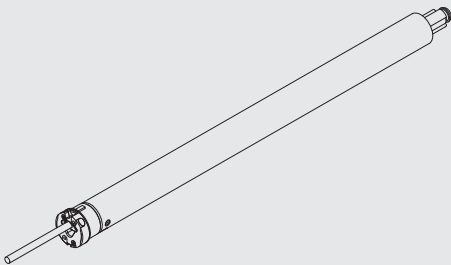

- Motor length: 545mm
- Voltage: 120 V AC
- Torque: 3 Nm
- Speed: 36 rpm
- Frequency: 60 Hz
- Power: 138 W
- Current: 1.15 A
- Thermal overload Protection
- CE Standard
- Cable pluggable
- Max. Weight Capacity: 7.5 kg

The system can be operated as standard via a fixed wall switch or radio remote control (see next option)

#### <b>Operation via Fixed Switch</b>

System can be operated using fixed switch

4770

### Motor Silent Gliss 11241/11244 (40 Series)

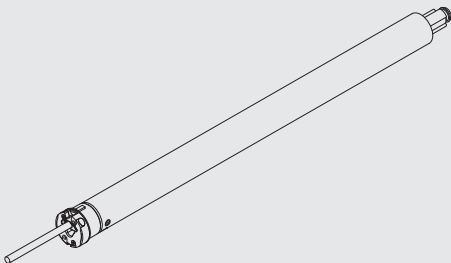

- Motor length 11241: 755mm
- Motor length 11244: 485mm
- Motor 11241: 230V supply
- Motor 11244: 24V DC supply
- Dry contact switched
- Integrated 9940 radio receiver
- Torque: 3Nm
- Speed: 32rpm maximum (adjustable)
- Power: 1.5A



## Operation with Radio Remote Control System 9940

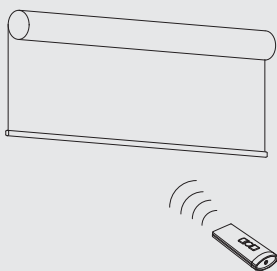

All Series 40 motors include an integrated receiver for use with Silent Gliss 9940 radio control system.

## Silent Gliss Move App

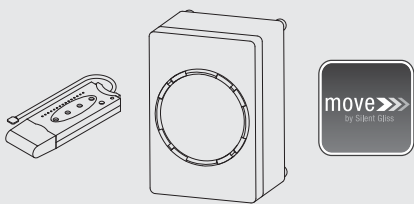

Operation of system with Silent Gliss Move app using a smartphone, tablet or desktop.

Whether at home or on the road, this reliable and intuitive app allows to program automatic opening and closing times. Furthermore, automatic sunrise and sunset time programming and groups and moods are possible.

The app is available for Android, IOS and Windows and can be downloaded in the respective app stores. Additionally, the Move Server Set Silent Gliss 9960 is required.

## Motor Silent Gliss 11251 (Smart)

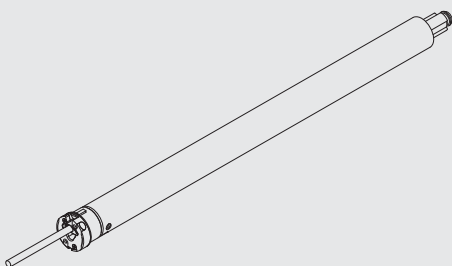

- Smart motor to allow integration and control by most major smart home control systems
- Maximum speed: 32rpm (adjustable)
- Torque: 3Nm
- Must be used in conjunction with Silent Gliss Gateway controller and associated components.

## Wiring and Connections

For other operating / wiring methods, please see section "Motors & Controls".

Supplied by



[www.sg-s.co.uk](http://www.sg-s.co.uk) email: [sales@sg-s.co.uk](mailto:sales@sg-s.co.uk) tel: 01395 232528

[www.silentgliss.co.uk](http://www.silentgliss.co.uk)

[www.silentglissglobal.com](http://www.silentglissglobal.com)

Silent Gliss Ltd  
Pyramid Business Park  
Poorhole Lane  
Broadstairs  
Kent  
CT10 2PT  
Great Britain

Tel: +44 (0) 1843 863571  
Fax: +44 (0) 1843 864503  
[info@silentgliss.co.uk](mailto:info@silentgliss.co.uk)

Silent Gliss Global Ltd  
Pyramid Business Park  
Poorhole Lane  
Broadstairs  
Kent  
CT10 2PT  
Great Britain

Tel: +44 (0) 1843 874250  
Fax: +44 (0) 1843 874457  
[info@silentglissglobal.com](mailto:info@silentglissglobal.com)