

Motorised Dim-Out Blind System

Silent Gliss® 4780 Large

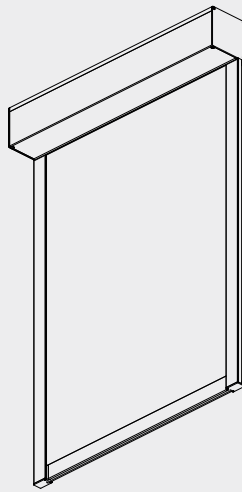

Product Information

- Technically advanced motorised dim-out blind system.
- Up to 3m wide, 3m high or 9m² with a maximum weight of 6kg.
- Easy click-in side profiles.
- Inside or outside recess fitting.
- Supplied powder coated black or white.
- Fabrics are 'zipped' into the side profiles.
- Delivered ready-assembled made-to-measure.
- Suitable for inclined positions up to 15° from vertical.
- Applicable with Radio Remote Control System Silent Gliss 9940 and Silent Gliss Move app.
- Optional Smart motor to allow integration and control by most major home control systems

4780

Profile and Bending Information

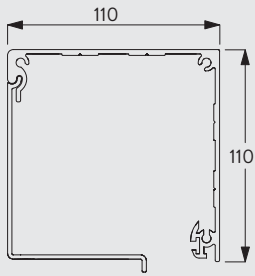

10998-9

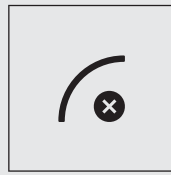

Cannot be bent

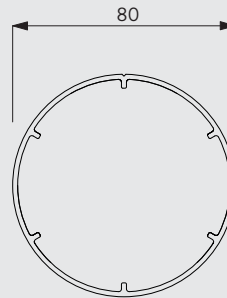

11003

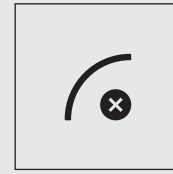

Cannot be bent

Specification Text

With Series 20 Motors

Silent Gliss 4780 Electrically Operated Dim-Out Roller Blind System with SG Series 40 motors for blinds up to 3m wide by 3m drop, max 9.0 sq.m.. Supplied made to measure and complete comprising aluminium cassette headbox 10998-9/110mm and frame finished in white or black as standard. Supplied with easy click-in side profiles 11001/ 11002 and fabrics are 'zipped' into the side profiles. Can be operated at up to a 15° from vertical. Integral 230v 50 Hz powered motor. Operation by mains switch (not supplied) or mains switching by third party control system or / SG 0450 remote control system (wireless controls at extra cost). All wiring to be strictly in accordance with Silent Gliss wiring diagrams. Fabric to be chosen from the Silent Gliss fabric range, Price Group 1R / 2R / 3R

With Series 40 Motors

Silent Gliss 4780 Electrically Operated Dim-Out Roller Blind System with SG Series 40 motors for blinds up to 3m wide by 3m drop, max 9.0 sq.m.. Supplied made to measure and complete comprising aluminium cassette headbox 10998-9/110mm and frame finished in white or black as standard. Supplied with easy click-in side profiles 11001/ 11002 and fabrics are 'zipped' into the side profiles. Can be operated at up to a 15° from vertical. Integral 24V DC* /100-240 V AC 50/60Hz motor. (*24V DC transformer not included). Operation by dry contact switching either from fixed switch (not supplied) or third party control system and / or Silent Gliss 9940 radio control system via integrated receiver. (9940 control components supplied at additional cost). All wiring to be strictly in accordance with Silent Gliss wiring diagrams. Fabric to be chosen from the Silent Gliss fabric range, Price Group 1R / 2R / 3R.

With Smart Motors

Silent Gliss 4780 Electrically Operated Dim-Out Roller Blind System with Smart by Silent Gliss motors for blinds up to 3m wide by 3m drop, max 9.0 sq.m.. Supplied made to measure and complete comprising aluminium cassette headbox 10998-9/110mm and frame finished in white or black as standard. Supplied with easy click-in side profiles 11001/ 11002 and fabrics are 'zipped' into the side profiles. Assembled with integral motor 10522 / 230v 50Hz. Can be operated at up to a 15° from vertical. Integral 24V DC powered Smart by Silent Gliss motor left / right side. Operation only via Silent Gliss Smart Gateway and associated components in conjunction with compatible third-party control systems. All wiring to be strictly in accordance with Silent Gliss wiring diagrams. Fabric to be chosen from the Silent Gliss fabric range, Price Group 1R / 2R / 3R.

4780

How To Measure

Inside fitting

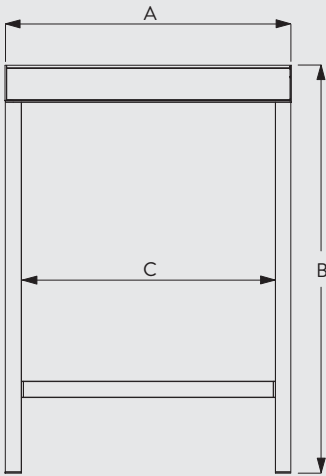

A: System width
B: System drop
C: Fabric width

Face fitting

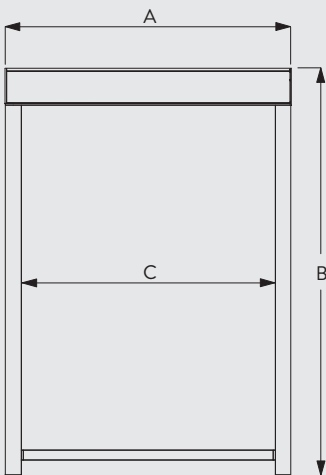

A: System width
B: System drop
C: Fabric width

4780

System Dimensions

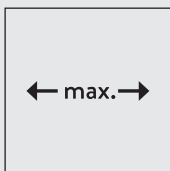

3m



65cm

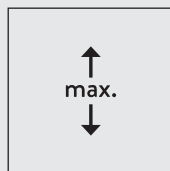

3m

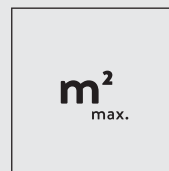

9m²



6kg

Please note: The max. system width/drop also depends on the fabric type.

System Options

Radio Remote Control System Silent Gliss 9940

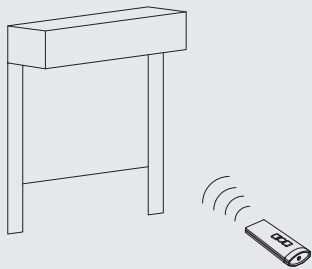

The Silent Gliss motors 10423 and 10523 feature an integrated radio receiver. Combined with the Radio Remote Control System Silent Gliss 9940, this system offers maximum comfort with minimum wiring.

The Silent Gliss motors 10422 and 10522 can be used with Radio Control System 0450 but will use an external radio receiver.

For further details, please refer to catalogue section "Motors & Controls".

Silent Gliss Move App

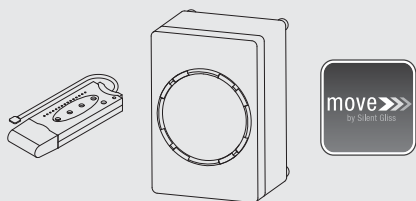

Operation of system with Silent Gliss Move app using a smartphone, tablet or desktop.

Whether at home or on the road, this reliable and intuitive app allows to program automatic opening and closing times. Furthermore, automatic sunrise and sunset time programming and groups and moods are possible.

The app is available for Android, IOS and Windows and can be downloaded in the respective app stores. Additionally, the Move Server Set Silent Gliss 9960 is required.

For further details, please refer to product group "Motors & Controls".

Smart by Silent Gliss

Silent Gliss offer Smart motor option 11251 which allows this dimout system to be integrated into, and controlled by most major home control systems.

Fitting Information

Positioning of drill holes

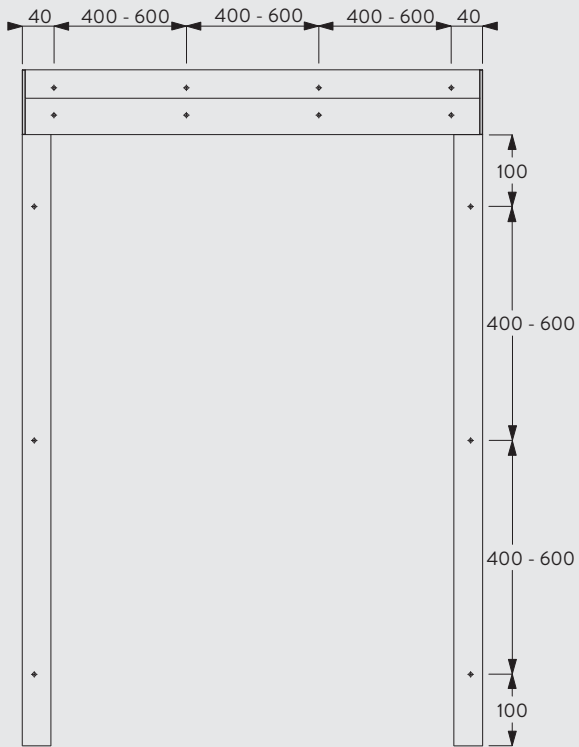

Side profiles 11001 and 11002

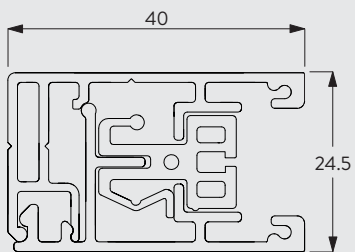

Drawing includes zip profile.

4780

Fitting Options

Ceiling fitting with direct mounting

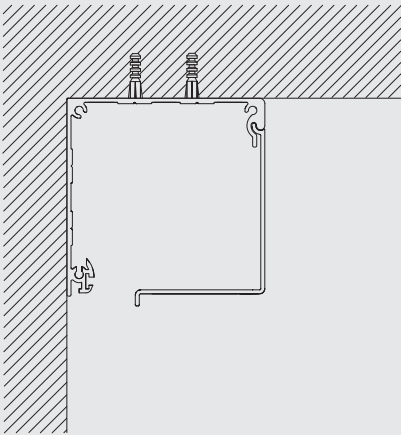

Wall fitting with direct mounting

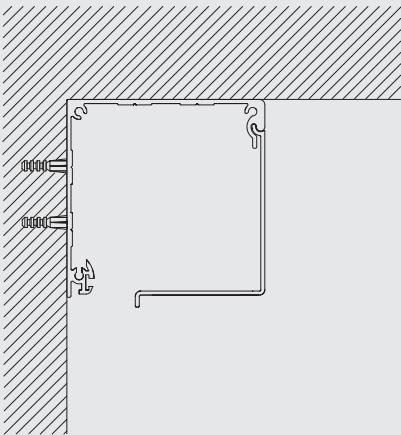

Recess fitting with direct mounting

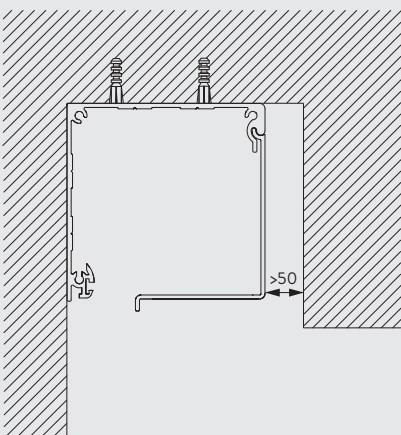

4780

















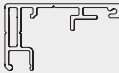
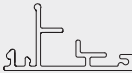











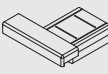





Standard Accessories

10284 O-Ring



10422 Motor 20-Series, 120 V

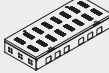

10423	Motor 20-Series, 120 V, radio receiver		10522	Motor 20-Series, 230V	
10523	Motor 20-Series, 230V, radio receiver		10668	Strip (10mm)	
10961	Zip profile		10993	Bottom weight	
11001	Side guide case		11002	Side guide cover	
11003	Profile tube, 80 mm		11008	Side cover left for box, 110 mm	
11009	Side cover right for box, 110 mm		11011	Clip for support	
11013	Clip for motor		11020	Tube adapter support 80 mm	
11022	Tube adapter motor 80 mm		11023	Motor drive 80 mm	
11024	Zip guide		11025	Zip	
11026	Cover left for side guide		11027	Cover right for side guide	
11028	Bottom weight guide left		11029	Bottom weight guide right	
11030	Bottom weight cover		10998-9	Box case and cover, 110 mm	
10520	Motor 20-Series, 120 V		11241	Motor 100-240V AC, 40-Series S 3/32, radio receiver	
11244	Motor 24V DC, 40-Series S 3/32, radio receiver		11251	Smart motor 24V DC	
11260	Smart controller gateway Cedia		11261	Smart controller gateway KNX	
11262	Smart expansion unit		11263	Power supply 24V DC, 2 Ampere DIN Rail	
11264	Power supply 24V DC, 3.8 Ampere DIN Rail		11265	Power supply 24V DC, 5 Ampere DIN Rail	
11266	Power supply 24V DC, 10 Ampere DIN Rail		11281	Cabinet for 8 systems	
11282	Cabinet for 24 systems		11283	Cabinet for 56 systems	

4780

11325 Smart plug 6-pin, MC 1.5/6 ST-3.81



Useful Measures

10993 Bottom weight

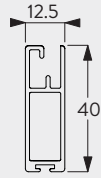

11008 Side cover left for box, 110 mm

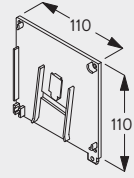

Motor & Controls

Motor Silent Gliss 10522/10523 (20 Series)

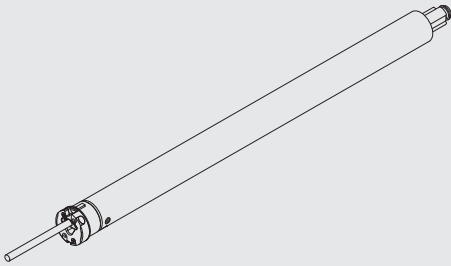

- Voltage: 120 V AC
- Frequency of receiver of motor 10523: 868 / 915 MHz
- Torque: 3Nm
- Speed: 30rpm
- Frequency: 50Hz
- Power: 135W
- Current: 0.60A
- Thermal Overload Protection
- CE Standard
- Cable pluggable
- Max. Weight Capacity: 7.5kg

Operation for motors 10522 /10523 is via fixed wall switch.

Motor Silent Gliss 10422/10423 (20 Series)

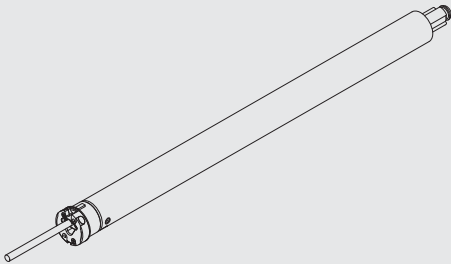

- Voltage: 120 V AC
- Frequency of receiver of motor 10423: 868 / 915 MHz
- Torque: 3 Nm
- Speed: 36 rpm
- Frequency: 60 Hz
- Power: 138 W
- Current: 1.15 A
- Thermal overload Protection
- CE Standard
- Cable pluggable
- Max. Weight Capacity: 7.5 kg<

Operation via Fixed Switch

System can be operated using fixed switch

Radio Remote Control System Silent Gliss 0450

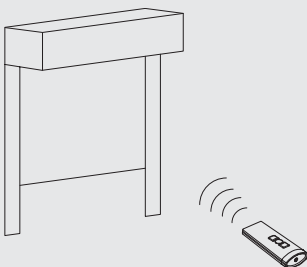

The Silent Gliss motors 10422 and 10522 can be used with Radio Control System 0450 but will use an external radio receiver.

These motors are not compatible with Radio Control System 9940 or the Move App. To use this system you must select 40 Series motors.
For further details, please refer to catalogue section "Motors & Controls".

4780

Motor Silent Gliss 11241/11244 (40 Series)

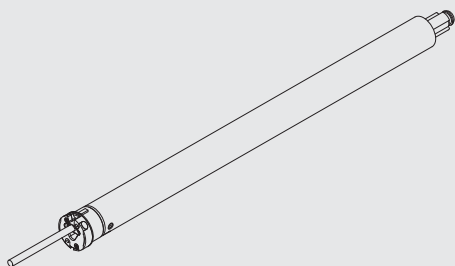

- Motor length 11241: 755mm
- Motor length 11244: 485mm
- Motor 11241: 230V supply
- Motor 11244: 24V DC supply
- Dry contact switched
- Integrated 9940 radio receiver
- Torque: 3Nm
- Speed: 32rpm maximum (adjustable)
- Power: 1.5A

Radio Remote Control System Silent Gliss 9940

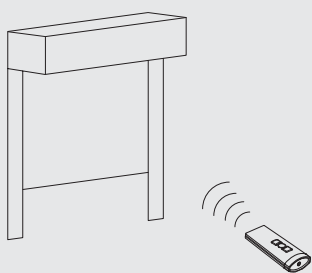

The Silent Gliss motors 10523 and 10423 feature an integrated radio receiver. Combined with the Radio Remote Control System Silent Gliss 9940, this system offers ease of operation with minimum wiring.

The Silent Gliss motors 10422 and 10522 can be used with Radio Control System 0450 but will use an external radio receiver.

Silent Gliss Move App

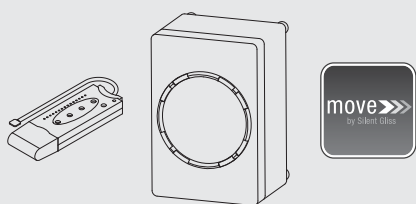

Whether at home or on the road, this reliable and intuitive app allows to program automatic opening and closing times. Furthermore, automatic sunrise and sunset time programming and groups and moods are possible.

The app is available for Android, IOS and Windows and can be downloaded in the respective app stores. Additionally, the Move Server Set Silent Gliss 9960 is required.

4780

Motor Silent Gliss 11251 (Smart)

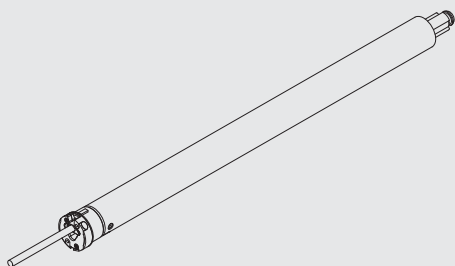

- Smart motor to allow integration into most major home control systems
- Max speed 32 rpm (adjustable)
- Must be used in conjunction with Silent Gliss Gateway controller and associated components.

Operation is via home control system and linked devices

Wiring and Connections

For other operating / wiring methods, please see section "Motors & Controls".

Supplied by



www.sg-s.co.uk email: sales@sg-s.co.uk tel: 01395 232528

www.silentgliss.co.uk

www.silentglissglobal.com

Silent Gliss Ltd
Pyramid Business Park
Poorhole Lane
Broadstairs
Kent
CT10 2PT
Great Britain

Tel: +44 (0) 1843 863571
Fax: +44 (0) 1843 864503
info@silentgliss.co.uk

Silent Gliss Global Ltd
Pyramid Business Park
Poorhole Lane
Broadstairs
Kent
CT10 2PT
Great Britain

Tel: +44 (0) 1843 874250
Fax: +44 (0) 1843 874457
info@silentglissglobal.com