

## Chain Operated Roller Blind System

# Silent Gliss® 4930

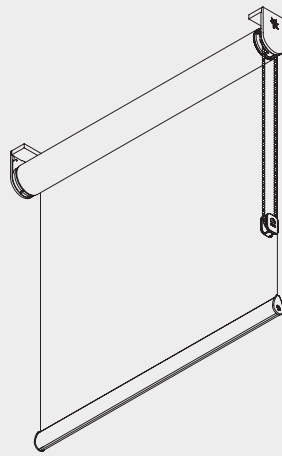

### Product Information

- Chain operated
- Smooth operation with unique planetary gear
- Easy installation with click-in brackets
- Bracket covers for neater appearance
- Corresponds to safety norms EN 13120, EN 16433 and EN 16434 - safety retainer included
- Ceiling, wall or recess fitting
- Options: connected double system with one drive, side-guides, installation profile

4930

## Profile and Bending Information

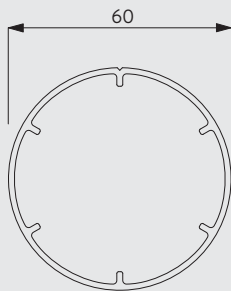

11037

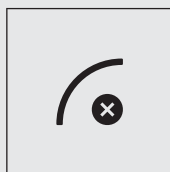

Cannot be bent

Specification Guide - download from [www.silentgliss.co.uk](http://www.silentgliss.co.uk) (password required).

Silent Gliss chain operated roller blind system for medium to medium/heavy weight fabric applications with unique planetary gear with integrated brake to ensure smooth operation and exact stopping with no slippage. Fixed to wall/ceiling/inside recess with 11172 brackets with top and side covers to ensure neat appearance. Optional installation profile 1181 with clamps 11180. Optional side guide wires. Side by side connected system 4930 can be operated simultaneously by one chain, fitted with 11183 connecting bolt and 11195 connecting adapter set.

## How To Measure

### Measurement Information: Single System

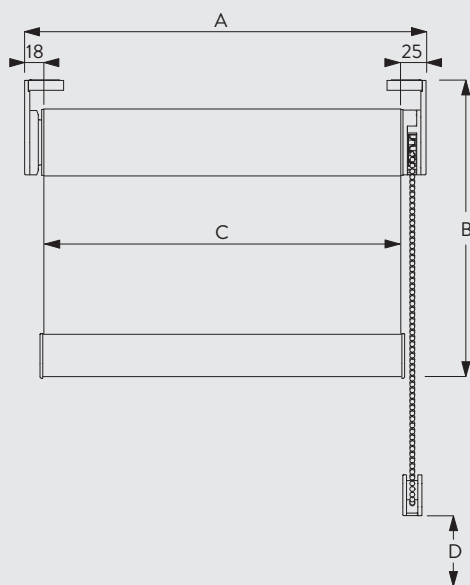

- A: system width
- B: system drop
- C: fabric width
- D: Safety Retainer 10400 min. 150 cm above floor

4930

## Measurement Information: Double (connected) System

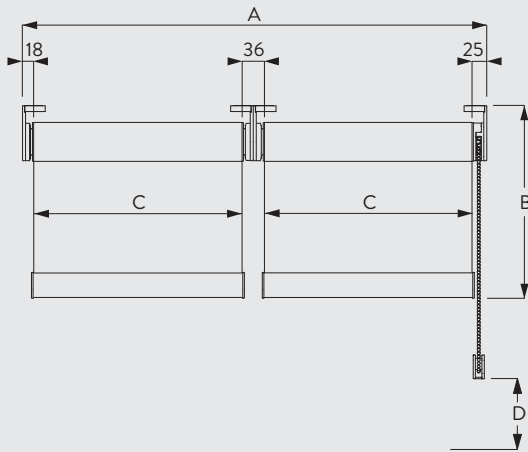

- A: system width
- B: system drop
- C: fabric width
- D: Safety Retainer 10400 min. 150 cm above floor

## System Dimensions

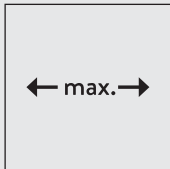

Single system: 3.4 m  
Double system: 6.8 m



65 cm

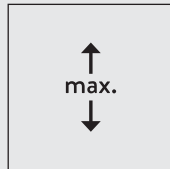

5 m



\*Single system: 17 m<sup>2</sup>  
\*Double system: 30 m<sup>2</sup>



Single system: 7 kg  
Double system: 7 kg

\*Max. m<sup>2</sup> depends on fabric type

## Fitting Information

### Alternative fixing with installation profile (optional)

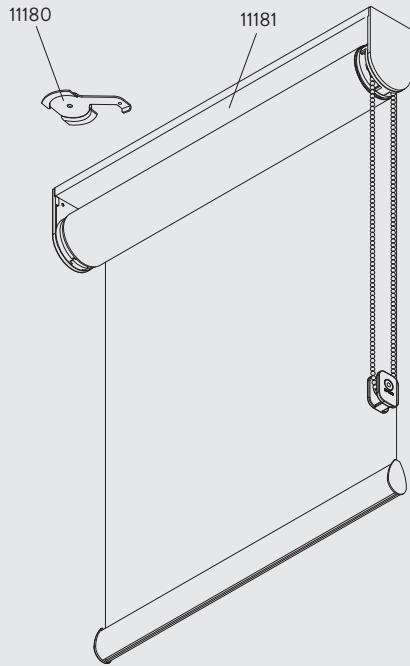

## Fitting Options

### Ceiling fitting with brackets

4930

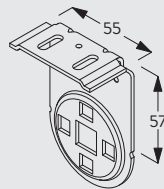
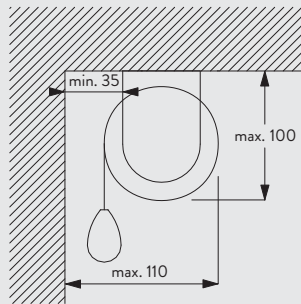

11172  
Bracket

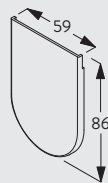

11173  
Bracket cover

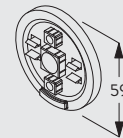

11175  
Click flange

All dimensions are based on the maximum system sizes and a fabric thickness of 0.8mm.

## Ceiling fitting with installation profile (option) and clamp 11180

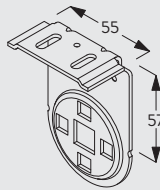
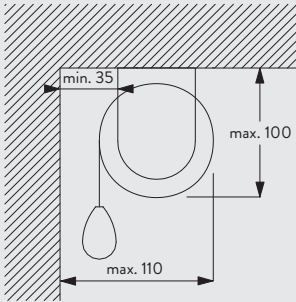

11172  
Bracket

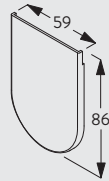

11173  
Bracket cover

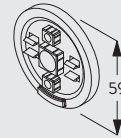

11175  
Click flange

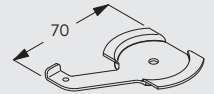

11180  
Clamp

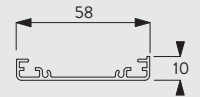

11181  
Profile

All dimensions are based on the maximum system sizes and a fabric thickness of 0.8mm.

## Wall fitting with brackets

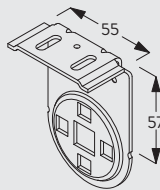
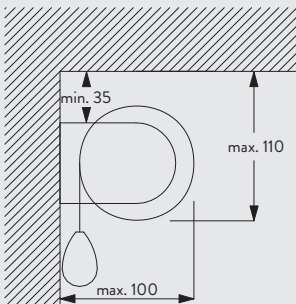

11172  
Bracket

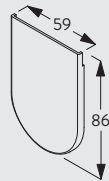

11173  
Bracket cover

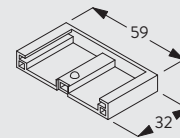

11174  
Top Cover

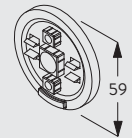

11175  
Click flange

All dimensions are based on the maximum system sizes and a fabric thickness of 0.8mm.

## Wall fitting with installation profile (option) and clamp 11180

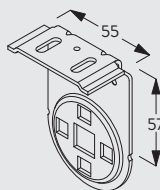
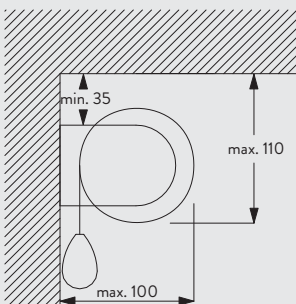

11172  
Bracket

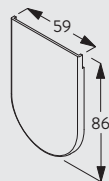

11173  
Bracket cover

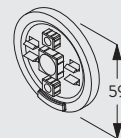

11175  
Click flange



11180  
Clamp

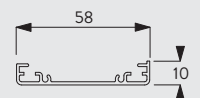

11181  
Profile

All dimensions are based on the maximum system sizes and a fabric thickness of 0.8mm.

4930

## Recess fitting with brackets

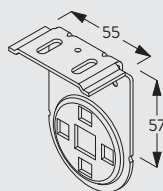
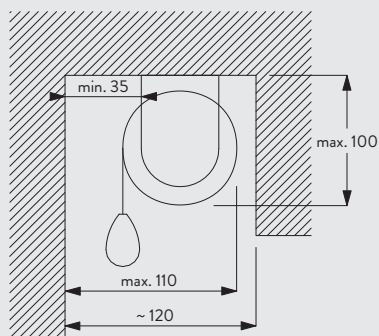

11172  
Bracket

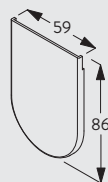

11173  
Bracket cover

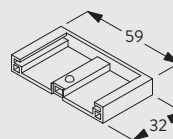

11174  
Top Cover

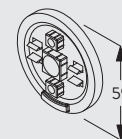

11175  
Click flange

All dimensions are based on the maximum system sizes and a fabric thickness of 0.8mm.

## Recess fitting with installation profile (option) and clamp 11180

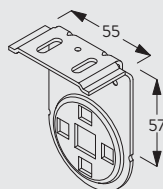
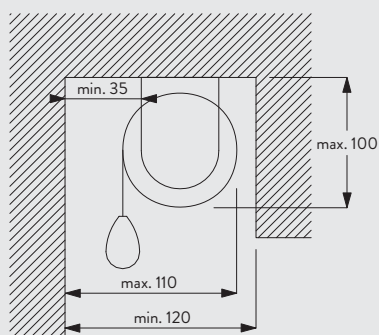

11172  
Bracket

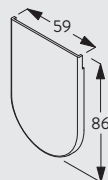

11173  
Bracket cover

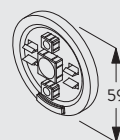

11175  
Click flange

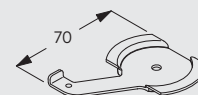

11180  
Clamp

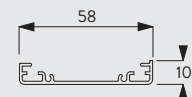

11181  
Profile

All dimensions are based on the maximum system sizes and a fabric thickness of 0.8mm.

## Standard Accessories

4223	Plastic strip 14 mm		4226	Standard adhesive tape	
4845	Metal bead chain (stainless steel or brass)		4903	Bottom bar	
10400	Safety Cord Retainer		10962	Chain drive	
11037	Profile tube, 60 mm		11165	Bearing	
11172	Bracket		11173	Bracket cover	

11174 Top Cover



11175 Click flange



11178 Cover



11179 Cover



## Optional Accessories

3036 Bracket (47mm)



4944 Bottom bar endcover set

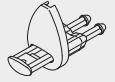

4948 Wire rope (ø 1,5mm)



8249 Locking ring



10498 Countersunk screw 2.9x9.5 DIN 7982C



10668 Strip (10mm)



10993 Bottom weight



11180 Clamp



11181 Profile

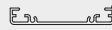

11182 Wire holder

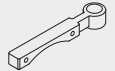

11183 Connecting bolt



11184 Bracket cover drilled



11195 Connecting adapter set



11197 End cover



11311 Bracket spacer



4930