

October 2011

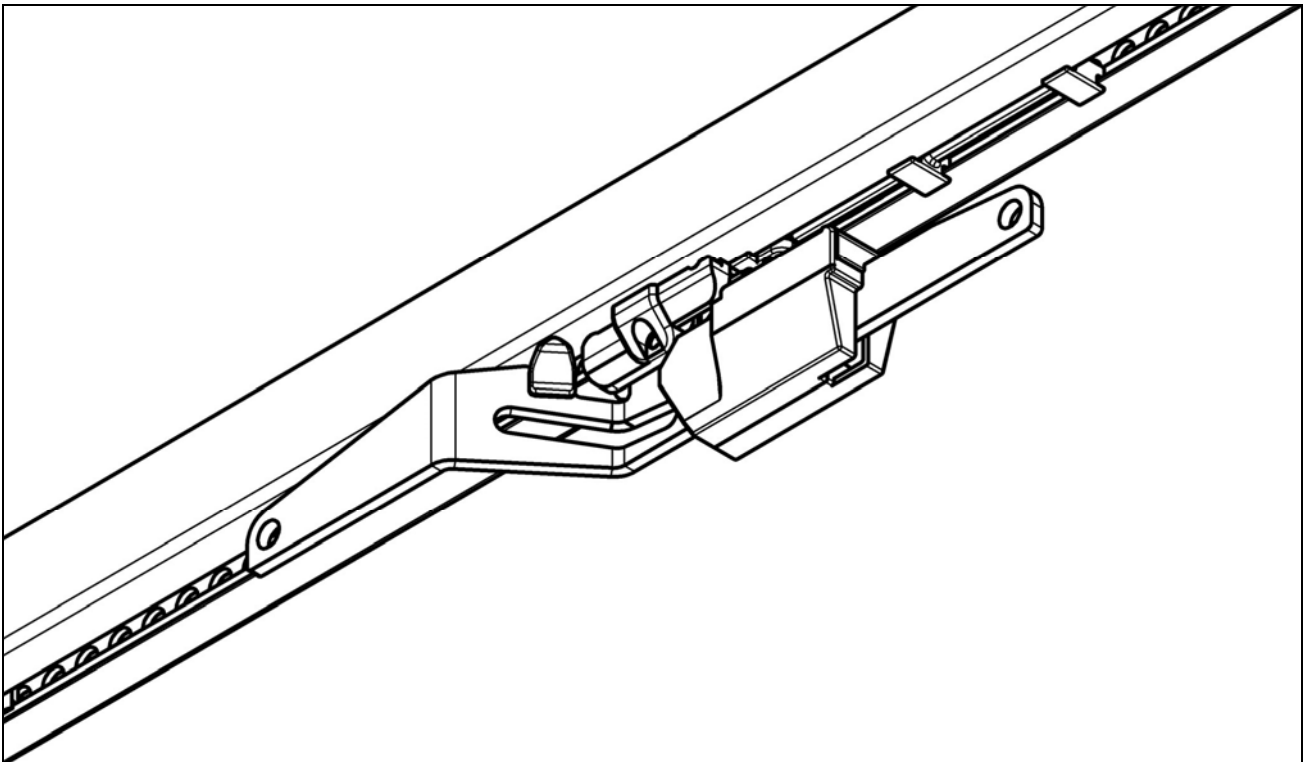

Silent Gliss® Manual Override

Silent Gliss® 5090

Silent Gliss® 5200

Silent Gliss® 5400

1 Product Information

1.1 Maximum Dimensions



5200 / 5400 10 m
5090 5 m









3 kg/m per system width
Total curtain weight:
10 kg max for bendable track (single stack)
18 kg max for bendable track (pair stack)
20 kg max for straight track (single stack)
30 kg max for straight track (pair stack)



Min. radius 25 cm

Weight Chart SG 5400 with Manual Override

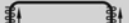





Option Manual Override

	2 m	4 m	6 m	8 m	10 m
	6	12	18	20	20
	6	12	18	24	29
	6	10	10	10	10
	6	12	18	18	15
	6	10	10	10	8
	6	12	18	12	8
	6	10	10	-	-
	6	12	12	-	-

(load limitation max. 3 kg per m)

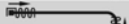
Weight Chart SG 5200 with Manual Override

Option Manual Override

	2 m	4 m	6 m	8 m	10 m
	6	12	18	15	10
	6	12	18	15	10
	6	10	10	10	-
	6	12	17	10	-
	6	10	10	8	-
	6	12	14	8	-
	6	10	8	-	-
	6	12	8	-	-

(load limitation max. 3 kg per m)

Weight Chart SG 5090 with Manual Override

Option Manual Override			
	2 m	4 m	5 m
	6	12	15
	6	12	15
	6	10	10
	6	10	10
	6	10	10
	6	10	10
	6	10	10
	6	10	10

(load limitation max. 3 kg per m)

Wave[®]

Not possible

**Wave
XL**

Not possible

1.2 System Configurations

Single Stack (1x)

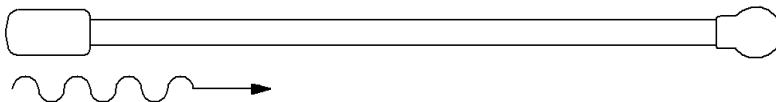

Pair Stack (1x2)

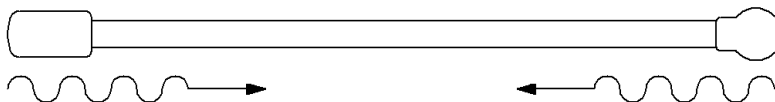

Multiple Stack (1x...)

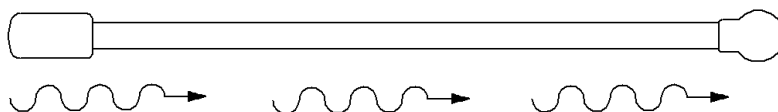

3 Sewing

3.1 Useful Information

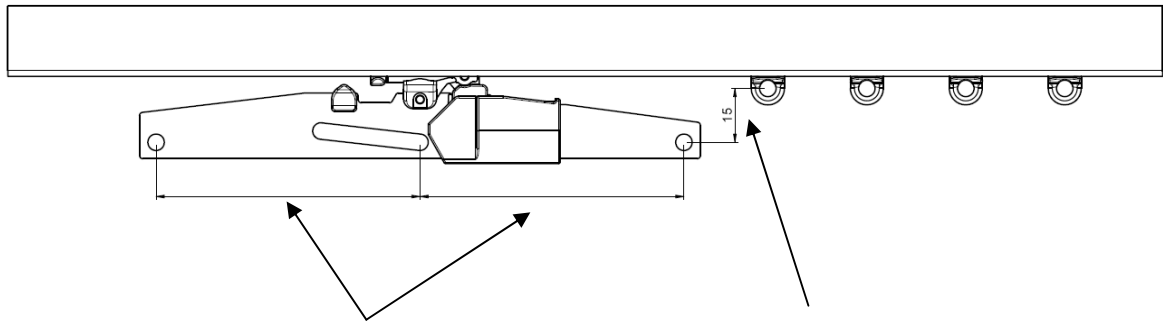

Manual Override hole distance 80 mm each

Distance Manual Override →
Glider SG 6083 +15 mm

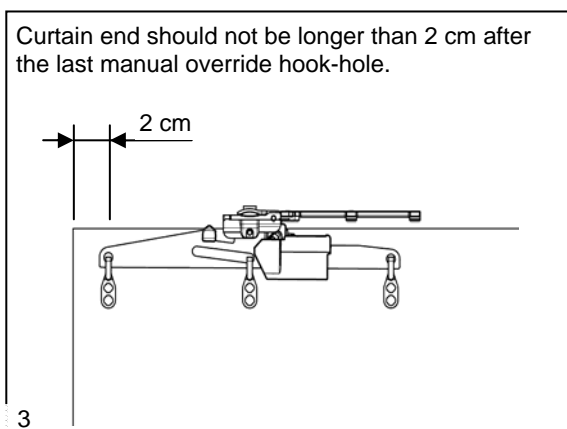
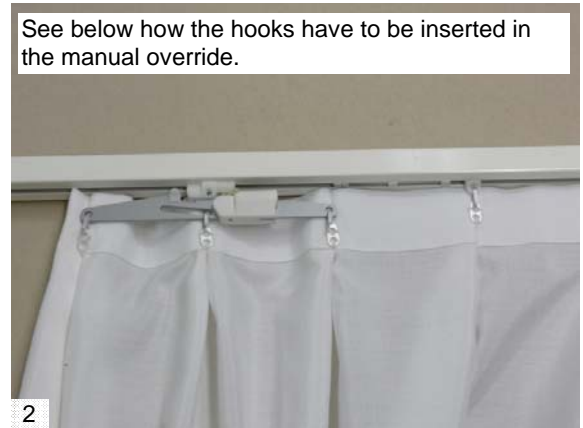

3.2 Glider

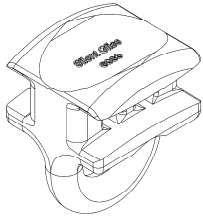

Note: - Only Glider SG 6083 can be used

3.3 Hooks

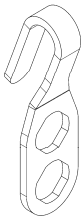

Hook 3012



Hook 3582



Hook 3599