

SG 6100M

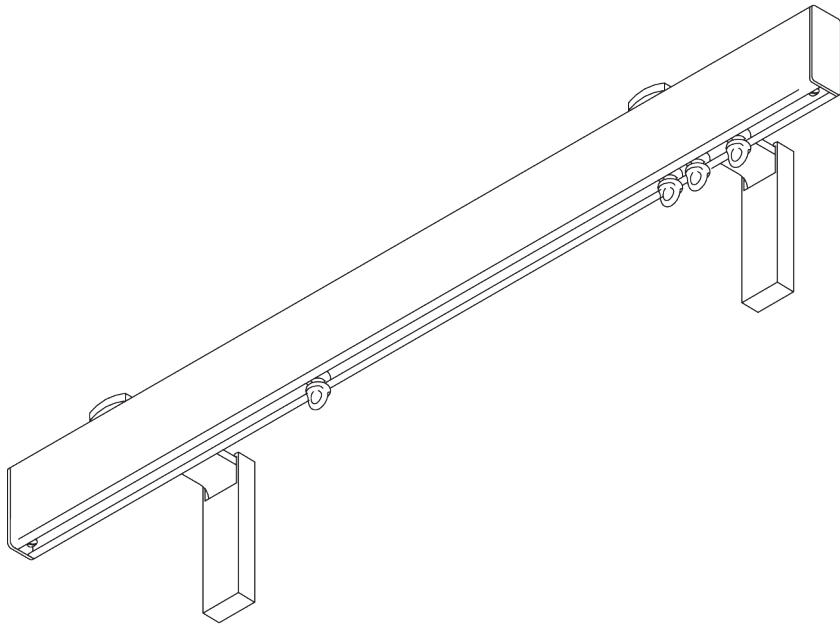
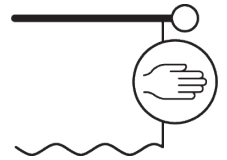

PRODUCT INFORMATION

- **Operation:** hand
- **Range:** M - L
- **Fitting:** ceiling, wall
- **Colours:** white RAL 9016, various colours / finishes
- **Fabrics:** refer to Silent Gliss fabric collection

Features:

- 2-component (2C) glider technology
- Wave (2C)
- Matching endcaps and brackets / bracket covers
- Range of decorative finials
- Bendable

SYSTEM SPECIFICATIONS

A. PROFILE

Profile and bending information

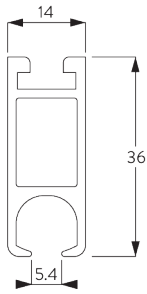

SG 6101

Profile



B. HOW TO MEASURE

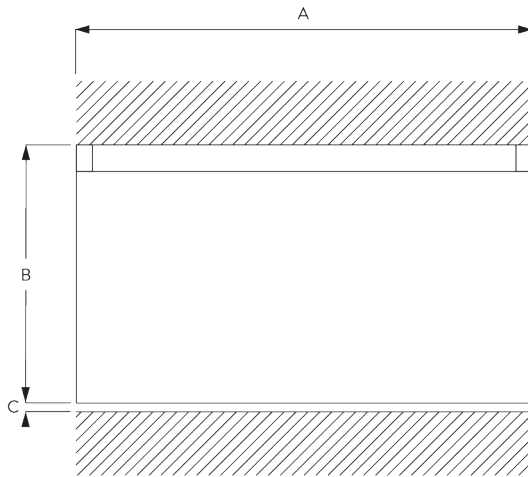

A: System width includes finials

B: System height

C: Distance between floor and fabric

C. SPECIFICATION

TEXT

Silent Gliss SG 6100 'Metropole' hand operated curtain track system. Comprises 36mm h x 14mm d aluminium profile SG 6100 supplied made to measure with 2C gliders SG 11300 at 14/m, 2 end flush covers SG 20351 and 2 no. end stops SG 6065. Straight poles supplied as standard with wall 'face' fix Smart Fix brackets SG 11206 at max. 600mm centres. Optional wall fix brackets SG11207-11208 / SG 11216-11218 / SG 11209 / Maxi bracket SG 20334 / Blok bracket SG 20989. Bent systems for wall 'face' fix supplied as standard with adjustable Smart Fix bracket SG 11209. Ceiling 'top' fix with bracket SG 6151 / SG 20335 at max. 600mm centres. Finished in Antique Bronze, Gunmetal, Black, Charcoal, Anodic Grey, Slate Grey, Matt White, White, Chrome Effect or Anodised Silver. A range of decorative finials are available. Silent Gliss Wave option is available using 60mm glider cord SG 11303/80mm glider cord SG 11302/80mm roller glider cord SG 6099.

FITTING

A. FITTING INFORMATION

For detailed fitting information, visit the Silent Gliss website.

Fixing points

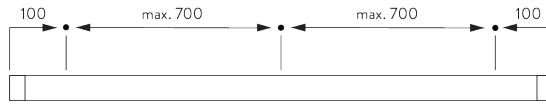

B. CEILING FITTING

Support SG 6151

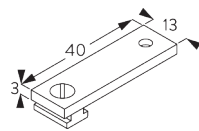
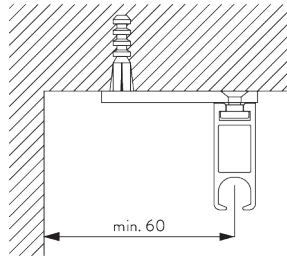

SG 6151

Ceiling support set 3 mm

Top fix bracket SG 20335

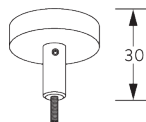
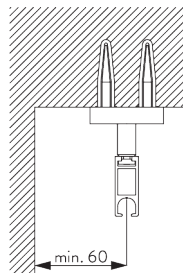

SG 20335

Top fix bracket

C. WALL FITTING

Smart Fix

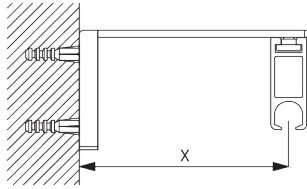

Smart Fix with slot SG 11206 - SG 11208 and SG 6141:
Screw SG 20798 (M4x10) needed.

Smart Fix	X mm
SG 11206 / SG 11216	51
SG 11207 / SG 11217	71
SG 11208 / SG 11218	91
SG 11209 / SG 11472	80-100

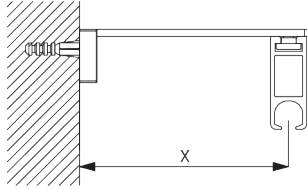

Square Smart Fix with slot SG 11216 - SG 11218 and SG 6141:
Screw SG 20798 (M4x10) needed.

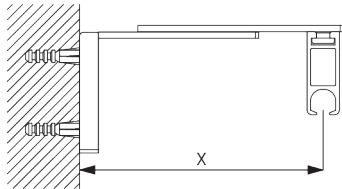

Adjustable Smart Fix SG 11209 and SG 6141:
Screw SG 6784 (M4x8) needed.

Note: all bent Metropole systems are supplied with adjustable bracket SG 11209 as standard.

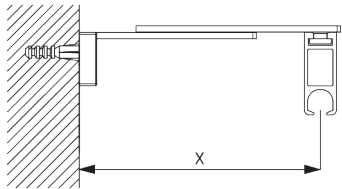

Adjustable Square Smart Fix SG 11472 and SG 6141:
Screw SG 6784 (M4x8) needed.

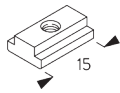

SG 6141
Clamping piece



SG 6784
Hexagon socket countersunk screw M4x8 mm

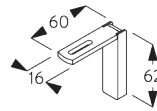

SG 11206
Smart Fix with slot 60 mm

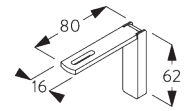

SG 11207
Smart Fix with slot 80 mm

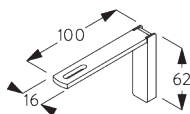

SG 11208
Smart Fix with slot 100 mm

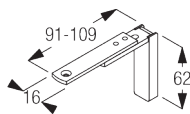

SG 11209
Adjustable Smart Fix

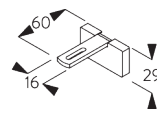

SG 11216
Square Smart Fix with slot 60 mm

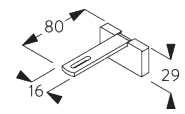

SG 11217
Square Smart Fix with slot 80 mm

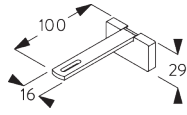

SG 11218

Square Smart Fix with slot
100 mm

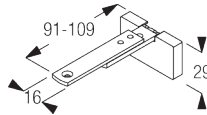

SG 11472

Adjustable Square Smart Fix



SG 20798

Hexagon socket countersunk
screw M4x10 mm

**Blok bracket
SG 20989**

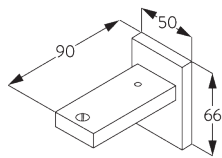
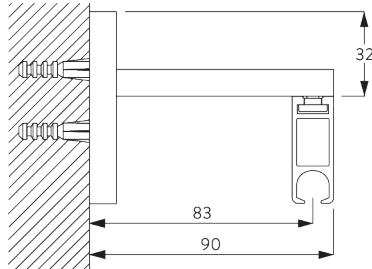

SG 20989

Blok bracket

DESIGN & SYSTEM OPTIONS

A. ENDCAPS

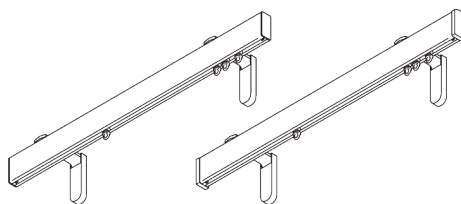

Without finials, poles are supplied as standard with flush fitting endcaps SG 20351 (left).

Alternatively, stud endcaps SG 20710 (right) can be selected at no additional cost.

B. FINIALS

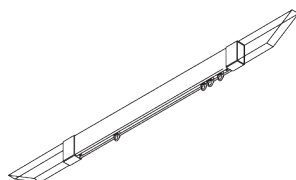

Finials are decorative elements that fit on at the end of the pole.

Please refer to the *Metropole brochure* for full range details.

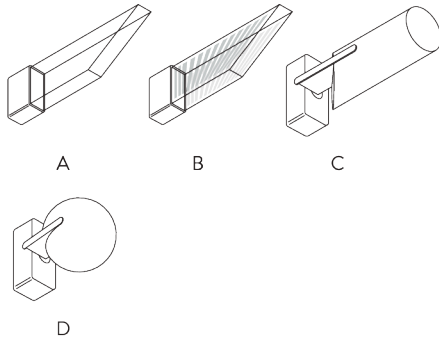

- A: SG 20991 Shard 116 mm (clear)
- B: SG 20991 Shard 116 mm (etched)
- C: SG 20304 Fused Barrel 102 mm (walnut, oak, colour matched)
- D: SG 20318 Fused Ball 63 mm (walnut, oak, colour matched)

C. WAVE

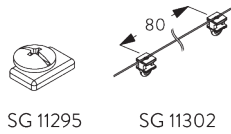
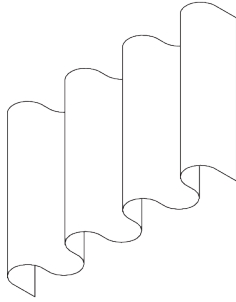

- Standard components:
- SG 11295 End stop
 - SG 11302 Wave 2C glider cord 80 mm

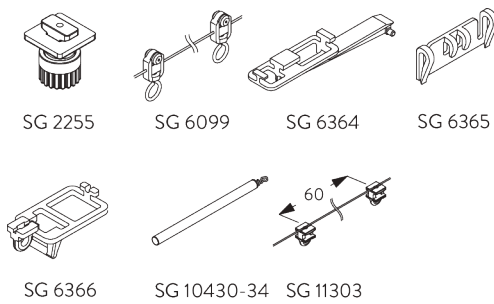

- Optional components:
- SG 2255 Brake
 - SG 6099 Wave roller cord 80 mm
 - SG 6364 Wave extension
 - SG 6365 Wave hanger
 - SG 6366 Wave carrier for draw rod
 - SG 10430-34 Draw rod
 - SG 11303 Wave 2C glider cord 60 mm

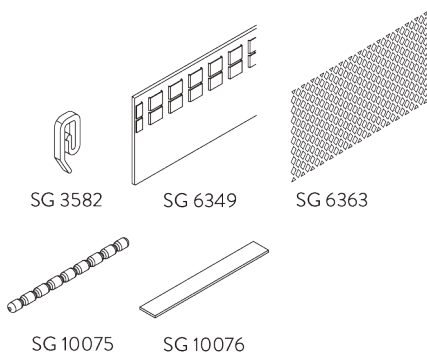

- Curtain components:
- SG 3582 Hook
 - SG 6349 Wave curtain tape
 - SG 6363 Wave top hemming tape
 - SG 10075 Lead weight 50 gr/m
 - SG 10076 Fabric weigh

Wave stack depth - 2C glider cord (standard components)

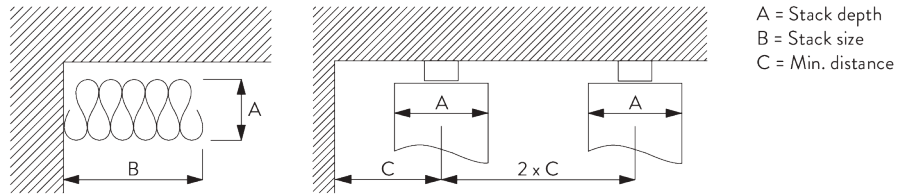

2C Glider cord SG 11302	Pockets between hooks	Approx. curtain fullness	Stack depth A	Stack size B*	Min distance C
80	6	~2.1	140	180 per metre of track	90
80	7	~2.3	160	180 per metre of track	100

2C Glider cord SG 11303	Pockets between hooks	Approx. curtain fullness	Stack depth A	Stack size B*	Min distance C
60	4	~2.1	100	230 per metre of track	70
60	5	~2.3	120	230 per metre of track	80

*Stack size B when using optional extension arm
SG 6364 increases by 95 mm per curtain stack!

GENERAL NOTES

Dimensions

- Measurements are in mm except where indicated.
- Max. kg relates to fabric incl. accessories.
- Stack size depends on curtain make-up and fabric thickness.
- Distance between gliders max. 80 mm / distance between rollers max. 100 mm.
- Recommended distance floor / fabric: 20 mm.
- In order to determine system height (B), the smallest room height must be taken into account.

Fitting

- Installation by qualified fitter only.
- Number of brackets and fitting positions / fixing points vary depending on fitting surface, system weight, fabric make-up, screw / fixing type and obstacles.
- Qualified fitter must use appropriate screws / fixings for each situation.
- Profile lip if applicable to be installed to room side.

Child Safety

- All relevant Silent Gliss systems correspond to child safety EN 13120.
- All parties involved must comply with EN 13120.

PARTS

A. STANDARD PARTS

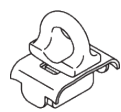

SG 6065

End stop



SG 6101

Profile



SG 6141

Clamping piece

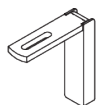

SG 11206

Smart Fix with slot 60 mm

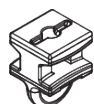

SG 11300

2C glider

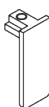

SG 20351

Metroflat endcap

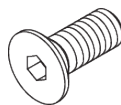

SG 20798

Hexagon socket countersunk screw
M4x10 mm



SG 2216

Cord \varnothing 0.85 mm

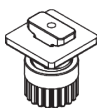

SG 2255

Brake



SG 3582

Hook

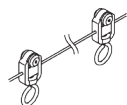

SG 6099

Wave roller cord 80 mm

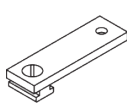

SG 6151

Ceiling support set 3 mm



SG 6283

Roller



SG 6349

Wave curtain tape

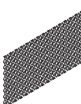

SG 6363

Wave top hemming tape

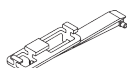

SG 6364

Wave extension

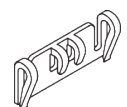

SG 6365

Wave hanger

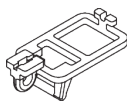

SG 6366

Wave carrier for draw rod

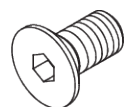

SG 6784

Hexagon socket countersunk screw
M4x8 mm



SG 10075

Lead weight 50 g/m



SG 10076

Fabric weight

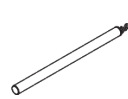

SG 10430

Draw rod 50 cm

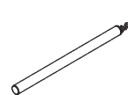

SG 10431

Draw rod 75 cm

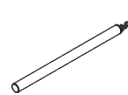

SG 10432

Draw rod 100 cm

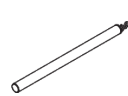

SG 10433

Draw rod 125 cm

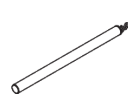

SG 10434

Draw rod 150 cm

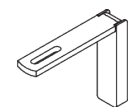

SG 11207

Smart Fix with slot 80 mm

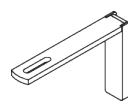

SG 11208

Smart Fix with slot 100 mm

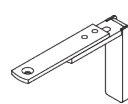

SG 11209

Adjustable Smart Fix

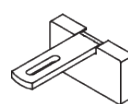

SG 11216

Square Smart Fix with slot 60 mm

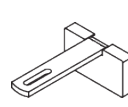

SG 11217

Square Smart Fix with slot 80 mm

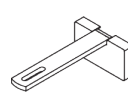

SG 11218

Square Smart Fix with slot 100 mm

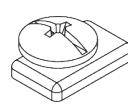

SG 11295

End stop



SG 11301

2C glider on strip

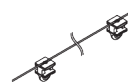

SG 11302

Wave 2C glider cord 80 mm

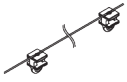

SG 11303

Wave 2C glider cord 60 mm

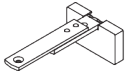

SG 11472

Adjustable Square Smart Fix

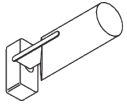

SG 20304

Fused barrel 102 mm

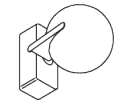

SG 20318

Fused ball 63 mm



SG 20335

Top fix bracket

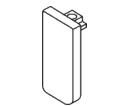

SG 20710

Stud endcap

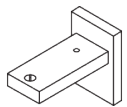

SG 20989

Blok bracket

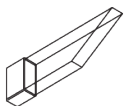

SG 20991

Shard 116 mm
