

Hand Operated Curtain Pole System

Silent Gliss® 6100M Metroflat 36mm

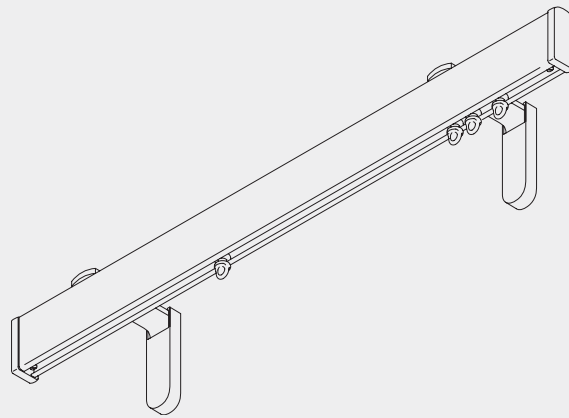

Product Information

- Hand operated system for domestic and contract applications
- Attractive contemporary appearance for modern interiors
- Can be bent to a small radius for bay windows
- Available in 7 finishes - chrome effect, silver, black, steel grey, bronze, antique bronze and gunmetal
- Accessorised with matching endcaps or glass finials
- Easy fitting to wall or ceiling
- For light to medium curtains
- Profile length 6m (chrome effect 4m)
- Suitable for Wave Standard and Wave XL curtain heading systems



6100M

Profile, Bending and Specification Information

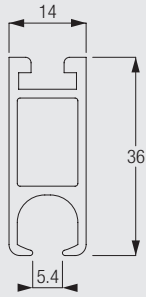

6101



Standard radius 200mm
Min. radius Wave XL: 500mm

Note: It is important to observe the above minimum bending radius for Wave XL. The system will not function with a smaller radius.

Specification Information - download from www.silentgliss.co.uk

Silent Gliss 6100M curtain track, hand drawn, aluminium, assembled complete with gliders 6143 at 10/m and 2 endcovers 0710. Ceiling fix with bracket 6138P each screwed to timber/plugged and screwed to block-work/concrete at 600mm centres. Finished in black, silver, gunmetal, bronze, antique bronze, steel grey or chrome effect.

How To Measure

Stack Size Calculation Wave Standard

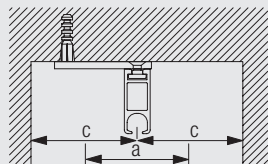
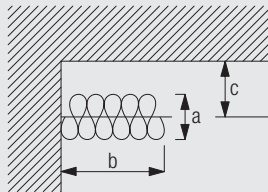

a = Stack depth
b = Stack size
c = Min. distance

Glider-cord spacing	Curtain hook spacing	Approx. curtain fullness	Stack depth (a)	Stack width (b)	Min distance (c)
6	10	1.9	10	23 per metre of track + endpiece	8
6	12	2.2	12	23 per metre of track + endpiece	9
8	14	2.0	14	18 per metre of track + endpiece	10
8	16	2.2	16	18 per metre of track + endpiece	11

Wave standard with roller gliders

Glider-cord spacing	Curtain hook spacing	Approx. curtain fullness	Stack depth (a)	Stack width (b)	Min distance (c)
8	14	2.0	14	21 per metre of track + endpiece	10
8	16	2.2	16	21 per metre of track + endpiece	11

(dimensions in cm)

Note: Minimum distance (c) includes a standard 4.5cm clearance (front and back).

Stack size calculation Wave XL

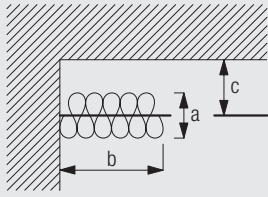

a = Stack depth 35cm
 b = Stack size
 c = Min. distance 22cm

System width		77-107	108-143	144-179	180-215	216-251	252-287	288-323	324-359	360-395
	b	21	26	31	36	41	46	51	56	61
System width		396-431	432-468	469-503	504-539	540-575	576-600			
	b	66	71	76	81	86	91			
System width		154-217	218-289	290-361	362-433	434-505	506-577	578-600		
	b	21	26	31	36	41	46	51		

(dimensions in cm)

Design Options

Finials

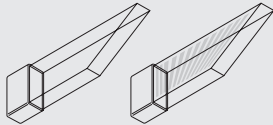
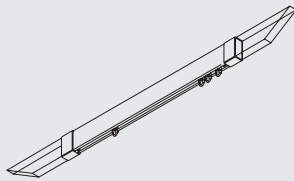

A

B

Finials are decorative elements that fix to the end of the pole.

A: 0991CL Shard (clear) 116mm
 B: 0991ET Shard (etched) 116mm

Wave Standard curtain heading system

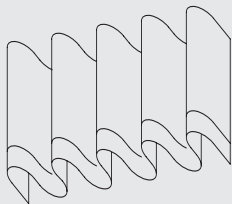

The Wave curtain heading system is an exciting contemporary curtain heading system which allows curtains to hang in a continuous wave which is smooth, simple and elegant.

When using the Wave curtain heading system please note the maximum recommended curtain weight is 2.5kg/m or 10kg/m with wave roller glider 6098W.

The Wave standard components are:

6345 Glider Cord 60mm
 6346 Glider Cord 80mm
 3582 Hook
 6349 Curtain tape
 6363 Iron-on top hemming tape
 6007 End stop

Additional optional Wave components:

2255 Adjustable brake
 6364 Extension (for use with 6365)
 6365 Hanger (for use with 6364)
 6366 Carrier for draw rod
 10075 Lead weight for bottom hem 50gr/m
 10076 Fabric weight for side of curtain
 6098W Wave roller glider 80mm



6100M

Wave XL curtain heading system

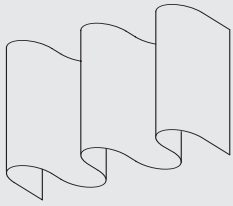

Wave XL is especially designed for high and large application areas through generously designed waves with large cross section dimensions.

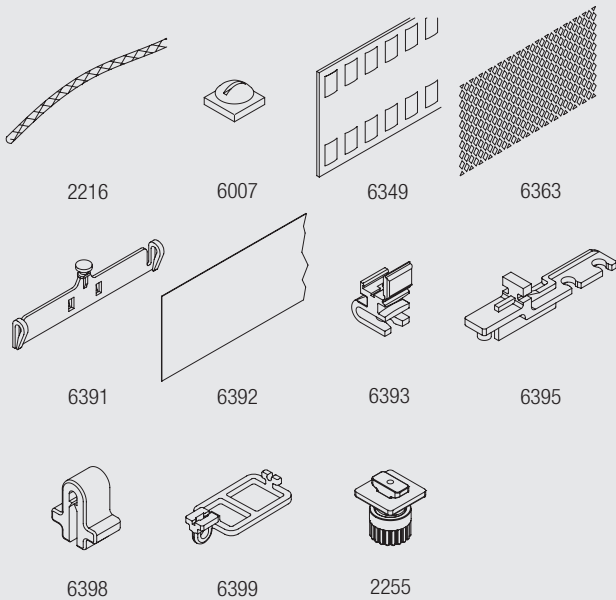

The Wave XL components are:

2216 Cord 0.85 mm
 2255 Adjustable brake
 6007 End stop
 6349 Curtain tape
 6363 Iron tape

Fitting Information

Bracket positioning when using brackets 3134/2-3136/2 or Ultra brackets 6133/6134

6100M

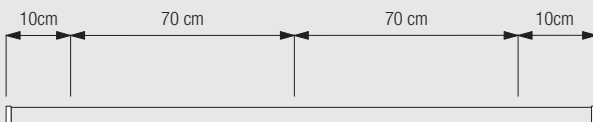

Fitting of track to brackets

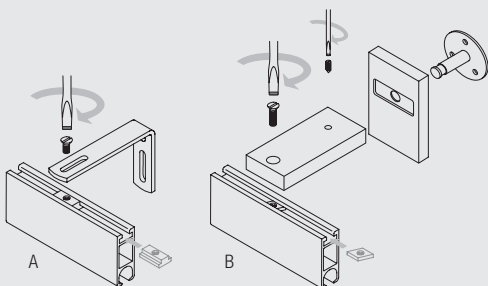

A: Using brackets 3134/2 - 3136/2
 B: Using Blok brackets 0989

Fitting Options

Wall fix with brackets 3134/2-3136/2

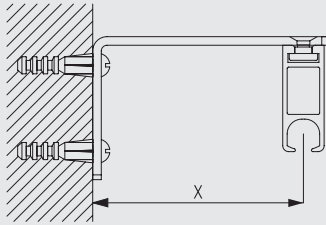

	X (mm)
3134/2	52
3135/2	72
3136/2	92

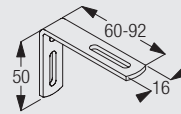

3134/2-3136/2
Extension brackets

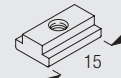

6141
Track insert (uses
screw 0798)

The final distances may be outside of the recommendations above depending on curtain heading, make-up and any obstructions.

Min. distance from wall when using Wave XL: 220mm.

Wall fix with Blok brackets 0989

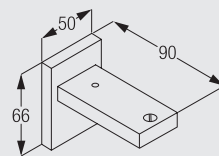
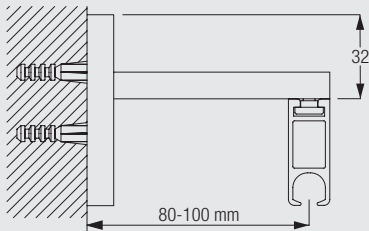

0989
Blok Bracket

The final distances may be outside of the recommendations above depending on curtain heading, make-up and any obstructions.

Min. distance from wall when using Wave XL: 220mm.

Ceiling fix with support 6138P

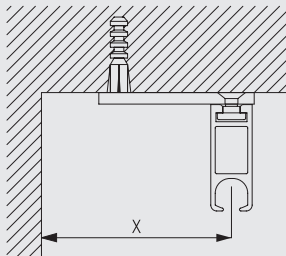

X (mm)
80-100

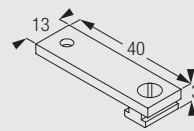

6138p
Ceiling support set
(3mm)

The final distances may be outside of the recommendations above depending on curtain heading, make-up and any obstructions.

Min. distance from wall when using Wave XL: 220mm.

Wall fix with adjustable bracket 0537

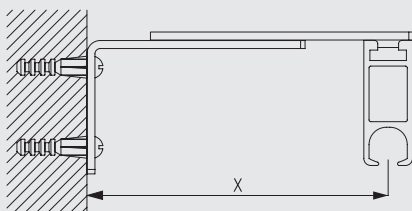

	X (mm)
0537	80-100

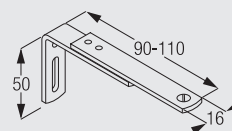

0537
Adjustable bracket

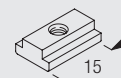

6141
Track insert (uses
screw 0798)

The final distances may be outside of the recommendations above depending on curtain heading, make-up and any obstructions.

Min. distance from wall when using Wave XL: 220mm.



6100M









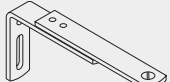
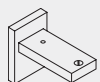

Standard Accessories

Parts

0710	Endcap		3133	Bracket cover (60mm)	
3134	Extension bracket (60mm)		6065	Twist eye endstop	
6101	Profile		6141	Track insert (uses screw 0798)	
6143	Glider 6144 in strip form		6784	Machine screw (for 6141 insert)	

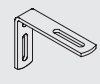

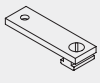

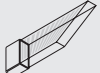



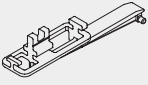

Optional Accessories

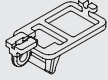
Parts

0537	Adjustable bracket		0989	Blok Bracket	
2216	Cord		3582	Hook	
6117	Track insert		6283	Roller glider	
6398	Clip		3135/2	Pole extension bracket (80mm - all colours)	
3136/2	Pole extension bracket (100mm - all colours)		6138p	Ceiling support set (3mm)	
0991CL	Shard Clear Metroflat		0991ET	Shard Etched Metroflat	

Wave Accessories

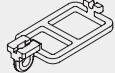
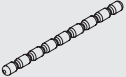
2216	Cord		2255	Adjustable brake	
2255	Adjustable brake		3582	Hook	
6007	Endstop		6345	Wave glider cord (60mm)	
6346	Wave glider cord (80mm)		6349	Wave curtain heading tape	

6363	Top hemming tape		6364	Extension	
6365	Hanger		6366	Carrier for draw rod	
6391	Hanger		6392	Heading film	
6393	Glider		6395	Extension	
6398	Clip		6399	Carrier for Draw rod	
10075	Lead weight 50 gr/m		10076	Fabric weight	
6098W	Wave roller glider cord (80mm)	