

SG 6120M

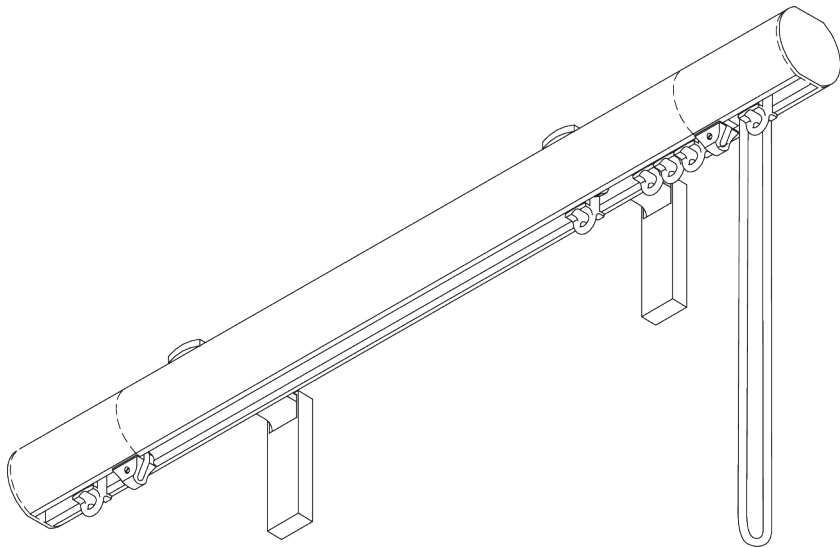
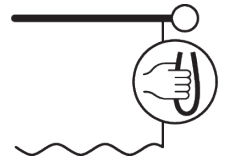

PRODUCT INFORMATION

- **Operation:** cord
- **Range:** M - L
- **Fitting:** ceiling, wall
- **Colours:** white RAL 9016, various colours / finishes
- **Fabrics:** refer to Silent Gliss fabric collection

Features:

- 2-component (2C) glider technology
- Wave (2C)
- Matching endcaps and brackets / bracket covers
- Range of decorative finials
- Bendable

SYSTEM SPECIFICATIONS

A. SYSTEM DIMENSIONS



6 m

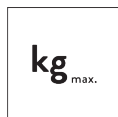

13 kg

Max. curtain weights

	Standard Application with Glider						Standard Application with Roller/ Wave Roller					
	1 m	2 m	3 m	4 m	5 m	6 m	1 m	2 m	3 m	4 m	5 m	6 m
	9	9	8	8	7	7	12	11	11	11	10	10
	10	10	9	9	8	8	13	13	12	11	11	10
	7	7	6	6	5	5	9	8	8	8	7	7
	8	8	7	7	6	6	10	9	9	9	8	8
	4	4	3	3	2	2	6	5	5	5	4	4
	5	5	4	4	3	3	7	6	6	6	5	5
	3	3	2	2	1	1	5	4	4	4	3	3
	4	4	3	3	2	2	6	5	5	5	4	4

(kg max.)

(kg max.)

B. PROFILE

Profile and bending information

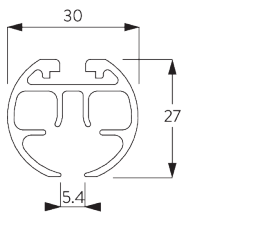

SG 6106

Profile

Radius:
✓ >30 cm

**C. HOW TO
MEASURE**

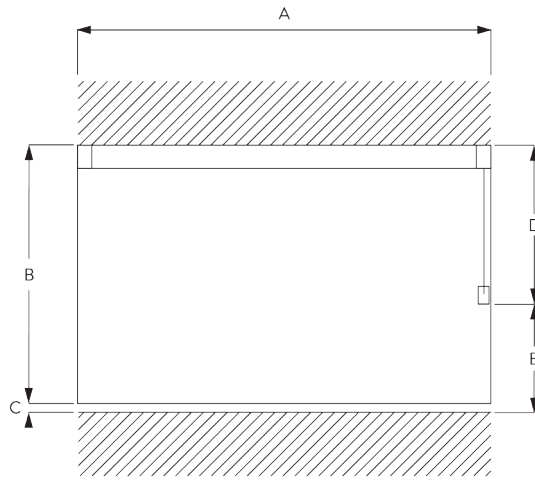

- A: System width
- B: System height
- C: Distance between floor and fabric
- D: Cord height
- E: Safety Retainer SG 10731 min. 150 cm above floor

**D. SPECIFICATION
TEXT**

Silent Gliss SG 6120 'Metropole' cord operated curtain track system. Comprises 30mm aluminium profile SG 6106 supplied made to measure with 2C gliders SG 11300 at 14/m, 2 end covers SG 20346, cord guide/return set SG 20340, overlap SG 6063 and cord SG 3091. Straight poles supplied as standard with wall 'face' fix Smart Fix brackets SG 11206 at max. 600mm centres. Optional wall fix brackets SG11207-11208 / SG 11216-11218 / SG 11209 / Maxi bracket SG 20334 / Blok bracket SG 20989 / Pillar bracket SG 20674. Bent systems for wall 'face' fix supplied as standard with adjustable Smart Fix bracket SG 11209. Ceiling 'top' fix with bracket SG 6151 / SG 20335 at max. 600mm centres. Finished in Ecru, Bronze, Antique Bronze, Gunmetal, Black, Charcoal, Anodic Grey, Slate Grey, Matt White, White, Sand, Ochre, Chrome Effect, or Taupe. A range of decorative finials are available. Silent Gliss Wave option is available using 60mm glider cord 11303 / 80mm glider cord 11302 / 80mm roller glider cord SG 6099. Compliant to Child Safety legislation EN 13120.

FITTING

**A. FITTING
INFORMATION**

For detailed fitting information, visit the Silent Gliss website.

Fixing points

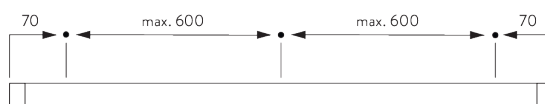

B. CEILING FITTING

Support SG 6151

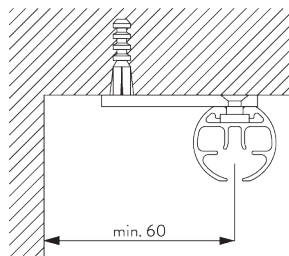

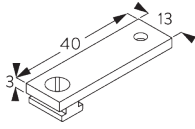

SG 6151

Ceiling support set 3 mm

**Top fix bracket
SG 20335**

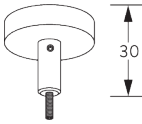
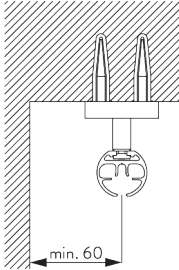

SG 20335

Top fix bracket

C. WALL FITTING

Smart Fix

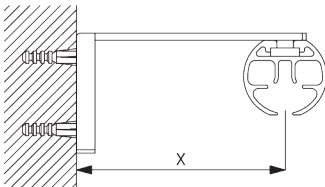

Smart Fix with slot SG 11206 - SG 11208 and SG 6141:
Screw SG 20798 (M4x10) needed.

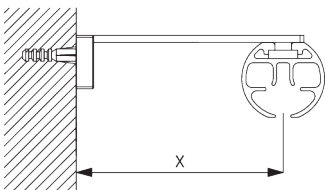

**Square Smart Fix with slot SG 11216 - SG 11218
and SG 6141:**
Screw SG 20798 (M4x10) needed.

Smart Fix	X mm
SG 11206 / SG 11216	51
SG 11207 / SG 11217	71
SG 11208 / SG 11218	91
SG 11209 / SG 11472	80-100

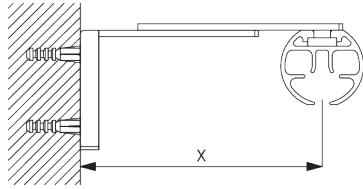

Adjustable Smart Fix SG 11209 and SG 6141:
Screw SG 6784 (M4x8) needed.

Note: all bent Metropole systems are supplied with adjustable bracket SG 11209 as standard.

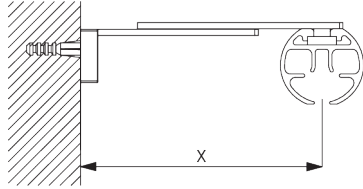

Adjustable Square Smart Fix SG 11472 and SG 6141:
Screw SG 6784 (M4x8) needed.

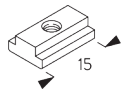

SG 6141
Clamping piece



SG 6784
Hexagon socket countersunk screw M4x8 mm

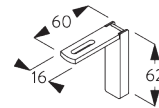

SG 11206
Smart Fix with slot 60 mm

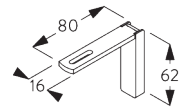

SG 11207
Smart Fix with slot 80 mm

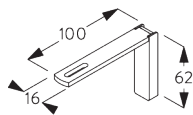

SG 11208
Smart Fix with slot 100 mm

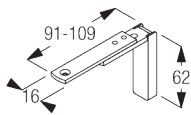

SG 11209
Adjustable Smart Fix

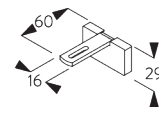

SG 11216
Square Smart Fix with slot 60 mm

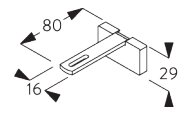

SG 11217
Square Smart Fix with slot 80 mm

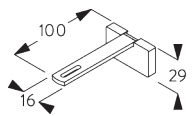

SG 11218
Square Smart Fix with slot 100 mm

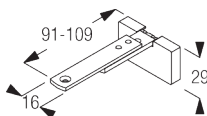

SG 11472
Adjustable Square Smart Fix



SG 20798
Hexagon socket countersunk screw M4x10 mm

**Pillar bracket
SG 20674**

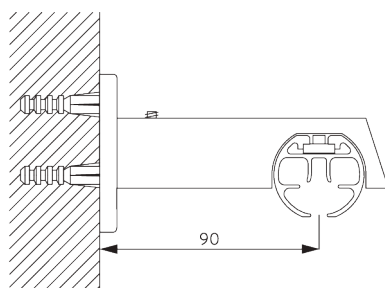

Screw SG 6784 (M4x8) needed.

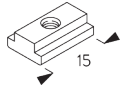

SG 6141
Clamping piece



SG 6784
Hexagon socket countersunk
screw M4x8 mm

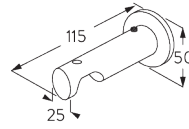

SG 20674
Pillar bracket 115 mm

**Maxi adjustable
bracket SG 20334**

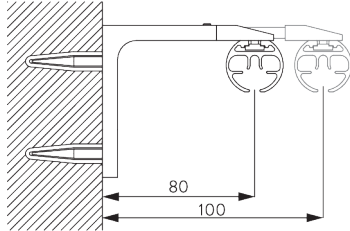

Screw SG 20798 (M4x10) needed.

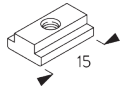

SG 6141
Clamping piece

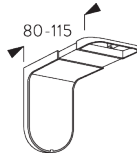

SG 20334
Maxi adjustable bracket



SG 20798
Hexagon socket countersunk
screw M4x10 mm

**Blok bracket
SG 20989**

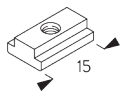
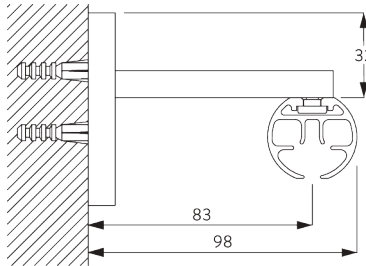

SG 6141
Clamping piece

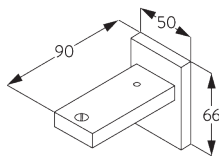

SG 20989
Blok bracket

DESIGN & SYSTEM OPTIONS

A. ENDCAPS

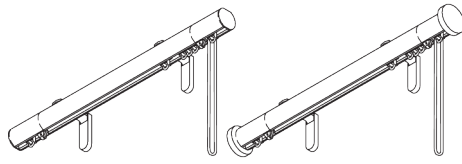

Without finials, poles are supplied as standard with flush fitting endcaps SG 20346 (left).

Alternatively, stud endcaps SG 20707 (right) can be selected at no additional cost.

B. FINIALS

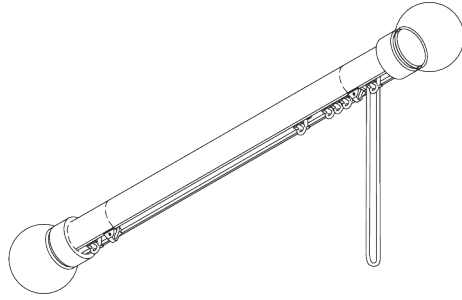

Finials are decorative elements that fit on at the end of the pole.

Please refer to the Metropole brochure for full range details.

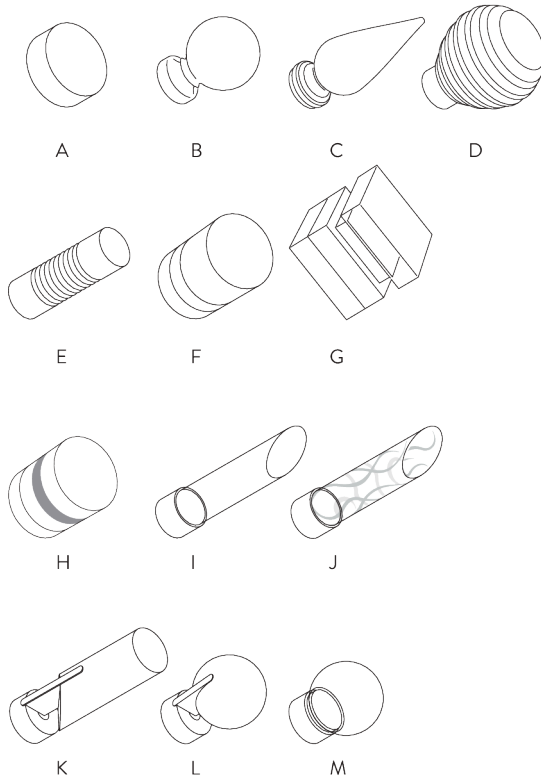

A: SG 20873 Design Endcap 20mm

B: SG 20556 Ball End 70mm

C: SG 20719 Spear 135mm

D: SG 20986 Groove Ball 85mm

E: SG 20629 Groove Cylinder 85mm

F: SG 20901 Strata 65mm

G: SG 20886 Crystal Cube 55mm
(green, black, brown)

H: SG 20896 Crystal Cylinder 55mm
(green, black, brown)

I: SG 20995 Shard Clear 127mm

J: SG 20995 Shard Etched 127mm

K: SG 20311 Fused Barrel 102mm
(walnut, oak, colour matched)

L: SG 20324 Fused Ball 60mm
(walnut, oak, colour matched)

M: SG 20331 Glass Ball 55mm
(clear, frosted)

C. WAVE

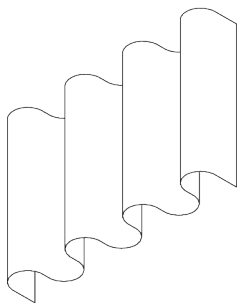

SG 11295

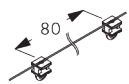

SG 11302

Standard components:

- SG 11295 End stop
- SG 11302 Wave 2C glider cord 80 mm

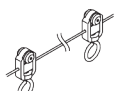

SG 6099

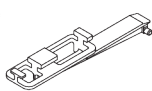

SG 6364



SG 6365

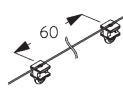

SG 11303

Optional component:

- SG 6099 Wave roller cord 80 mm
- SG 6364 Wave extension
- SG 6365 Wave hanger
- SG 11303 Wave 2C glider Cord 60 mm



SG 3582

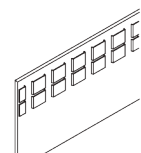

SG 6349

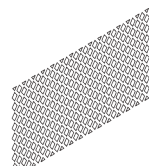

SG 6363

Curtain components:

- SG 3582 Hook
- SG 6349 Wave curtain tape
- SG 6363 Wave top hemming tape
- SG 10075 Lead weight 50 gr/m
- SG 10076 Fabric weigh

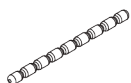

SG 10075



SG 10076

Wave stack depth - 2C glider cord (standard components)

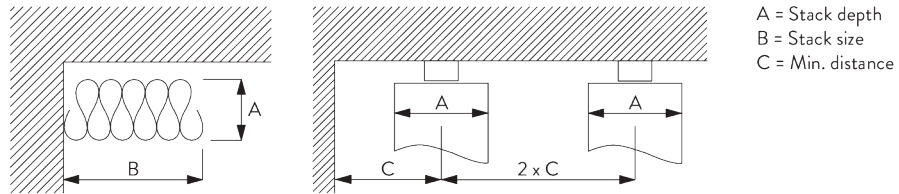

2C Glider cord SG 11302	Pockets between hooks	Approx. curtain fullness	Stack depth A	Stack size B*	Min distance C
80	6	~2.1	140	180 per metre of track	90
80	7	~2.3	160	180 per metre of track	100

2C Glider cord SG 11303	Pockets between hooks	Approx. curtain fullness	Stack depth A	Stack size B*	Min distance C
60	4	~2.1	100	230 per metre of track	70
60	5	~2.3	120	230 per metre of track	80

*Stack size B when using optional extension arm SG 6364 increases by 175 mm per curtain stack!

GENERAL NOTES

Dimensions

- Measurements are in mm except where indicated.
- Max. kg relates to fabric incl. accessories.
- Stack size depends on curtain make-up and fabric thickness.
- Distance between gliders max. 80 mm / distance between rollers max. 100 mm.
- Recommended distance floor / fabric: 20 mm.
- In order to determine system height (B), the smallest room height must be taken into account.
- Full functionality may be affected if the curtain touches the profile.

Fitting

- Installation by qualified fitter only.
- Number of brackets and fitting positions / fixing points vary depending on fitting surface, system weight, fabric make-up, screw / fixing type and obstacles.
- Qualified fitter must use appropriate screws / fixings for each situation.
- Profile lip if applicable to be installed to room side.

Child Safety

- All relevant Silent Gliss systems correspond to child safety EN 13120.
- All parties involved must comply with EN 13120.

PARTS

A. STANDARD PARTS

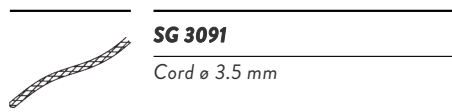

SG 3091
Cord ø 3.5 mm

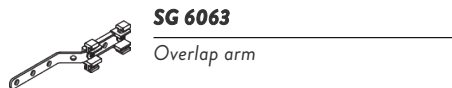

SG 6063
Overlap arm



SG 6065
End stop



SG 6106
Profile

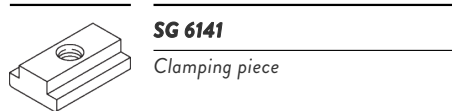

SG 6141
Clamping piece

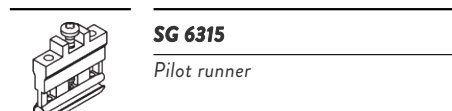

SG 6315
Pilot runner

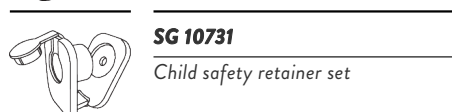

SG 10731
Child safety retainer set



SG 11206
Smart Fix with slot 60 mm

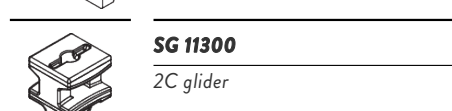

SG 11300
2C glider

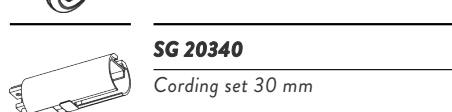

SG 20340
Cording set 30 mm

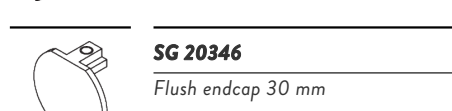

SG 20346
Flush endcap 30 mm

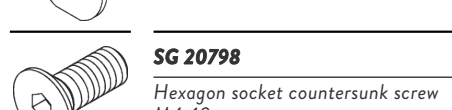

SG 20798
Hexagon socket countersunk screw
M4x10 mm

B. OPTIONAL PARTS



SG 3582
Hook



SG 6063
Overlap arm

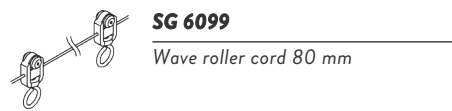

SG 6099
Wave roller cord 80 mm

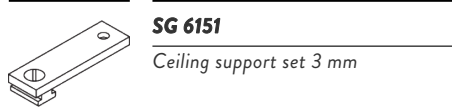

SG 6151
Ceiling support set 3 mm

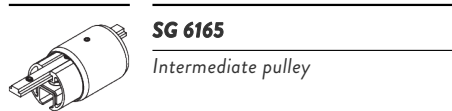

SG 6165
Intermediate pulley

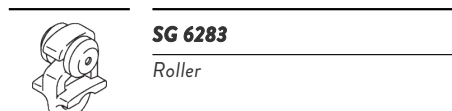

SG 6283
Roller

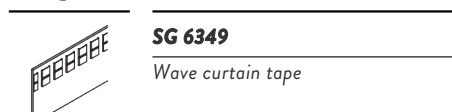

SG 6349
Wave curtain tape



SG 6363
Wave top hemming tape



SG 6364
Wave extension

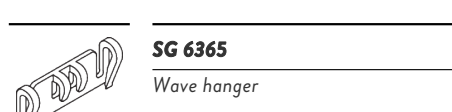

SG 6365
Wave hanger

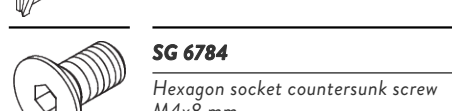

SG 6784
Hexagon socket countersunk screw
M4x8 mm



SG 10075
Lead weight 50 g/m

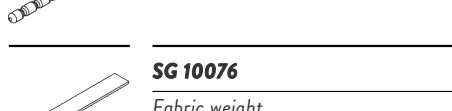

SG 10076
Fabric weight

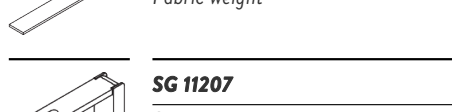

SG 11207
Smart Fix with slot 80 mm



SG 11208
Smart Fix with slot 100 mm

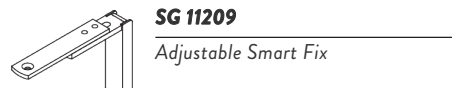

SG 11209
Adjustable Smart Fix

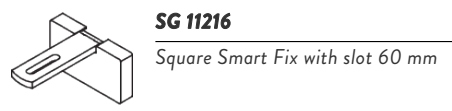

SG 11216
Square Smart Fix with slot 60 mm

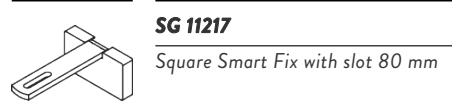

SG 11217
Square Smart Fix with slot 80 mm

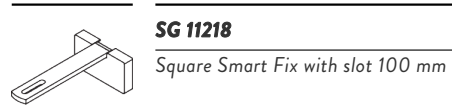

SG 11218
Square Smart Fix with slot 100 mm



SG 11295
End stop

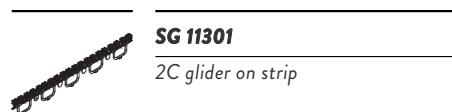

SG 11301
2C glider on strip

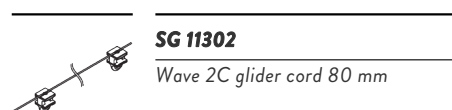

SG 11302
Wave 2C glider cord 80 mm

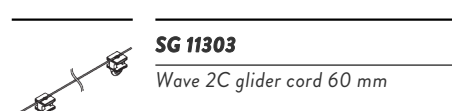

SG 11303
Wave 2C glider cord 60 mm

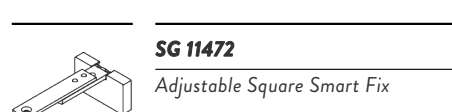

SG 11472
Adjustable Square Smart Fix

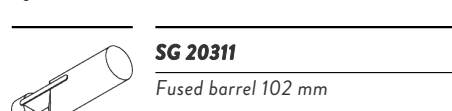

SG 20311
Fused barrel 102 mm

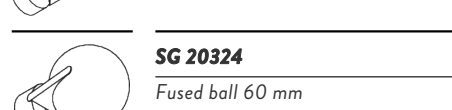

SG 20324
Fused ball 60 mm

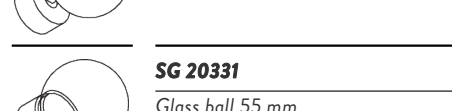

SG 20331
Glass ball 55 mm

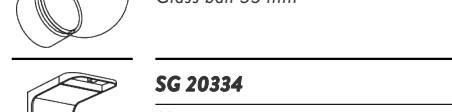

SG 20334
Maxi adjustable bracket



SG 20335

Top fix bracket

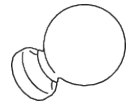

SG 20556

Ball end 70 mm

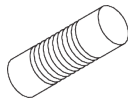

SG 20629

Groove cylinder 85 mm



SG 20674

Pillar bracket 115 mm

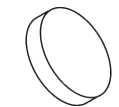

SG 20707

End cover 30 mm



SG 20719

Spear 135 mm

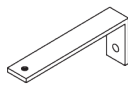

SG 20770

Finial connecting bracket

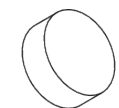

SG 20873

Design endcap 20 mm

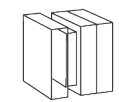

SG 20886

Crystal cube 55 mm

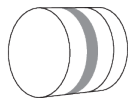

SG 20896

Crystal cylinder 55 mm

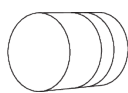

SG 20901

Strata 65 mm

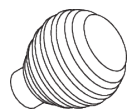

SG 20986

Groove ball 85 mm

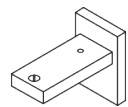

SG 20989

Blok bracket

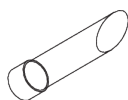

SG 20995

Shard 127 mm