

Hand Operated Curtain Pole System

Silent Gliss® 6130M Metropole 30mm

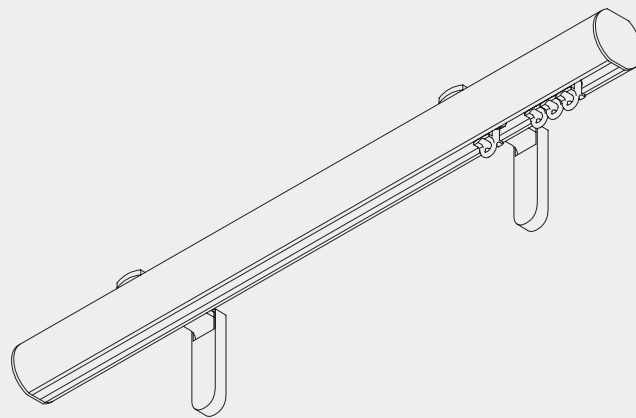

Product Information

- Hand operated system for domestic and contract applications
- Unlike other poles, 6130 can be bent to a small radius for bay windows
- Choice of 13 different finishes - cream, bronze, antique bronze, gunmetal, black, steel grey, white, sand, classic gold, chrome effect, anodised silver, taupe and oak effect
- Metropole is available with a range of finials offering a contemporary or traditional finish
- Accessorised with matching end caps and co-ordinated or matching brackets/bracket covers
- Easy fitting to wall or ceiling
- For medium to heavy curtains
- Profile Length 6m (classic gold and chrome effect 3.95m, oak effect 5m)
- Suitable for use with Wave Standard and Wave XL curtain heading systems



6130M

Profile and Bending Information

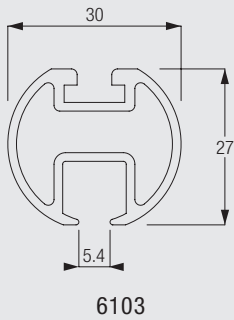

Standard radius 300mm
Wave XL: Min. radius 500mm

Note: It is important to observe the minimum bending radius for Wave XL. The system will not function with a smaller radius.

Specification Guide - download from www.silentgliss.co.uk (password required).

Silent Gliss 6130 curtain track, hand drawn, aluminium, assembled complete with gliders 6143 at 10/m and 2 endcovers 0346. Face fix with bracket 3134/2-36/2/ 0537/ 0674/ 0334/ top fix with bracket 6138P/ 0335 each screwed to timber/plugged and screwed to block-work/concrete at 600mm centres. Finished in black, white, sand, classic gold, gunmetal, steel grey, chrome effect, anodised silver, antique bronze, bronze, cream, taupe and oak effect.

How To Measure

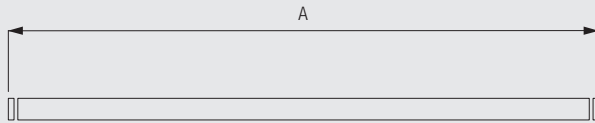

A: System Width - includes finials. See 'Design Options' for finial sizes.

Stack Size Calculation Wave Standard

6130M

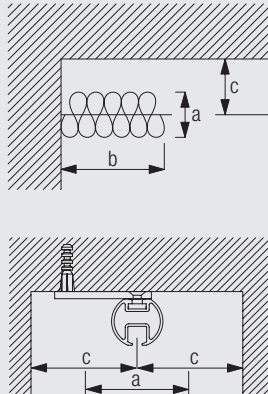

a = Stack depth
b = Stack size
c = Min. distance

Glider-cord spacing	Curtain hook spacing	Approx. curtain fullness	Stack depth (a)	Stack width (b)	Min distance (c)
6	10	2.1	10	23 per metre of track + endpiece	8
6	12	2.3	12	23 per metre of track + endpiece	9
8	14	2.1	14	18 per metre of track + endpiece	10
8	16	2.3	16	18 per metre of track + endpiece	11

Wave standard with roller gliders

Glider-cord spacing	Curtain hook spacing	Approx. curtain fullness	Stack depth (a)	Stack width (b)	Min distance (c)
8	14	2.1	14	21 per metre of track + endpiece	10
8	16	2.3	16	21 per metre of track + endpiece	11

(dimensions in cm)

Note: Minimum distance (c) includes a standard 3cm clearance (front and back).

Stack Size Calculation Wave XL

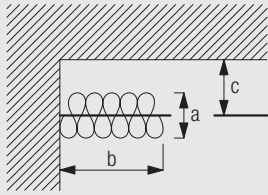

a = Stack depth 35cm
b = Stack size
c = Min. distance 22cm

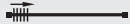
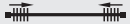
System width		77-107	108-143	144-179	180-215	216-251	252-287	288-323	324-359	360-395
	b	21	26	31	36	41	46	51	56	61
System width		396-431	432-468	469-503	504-539	540-575	576-600			
	b	66	71	76	81	86	91			
System width		154-217	218-289	290-361	362-433	434-505	506-577	578-600		
	b	21	26	31	36	41	46	51		

(dimensions in cm)

Design Options

Endcaps

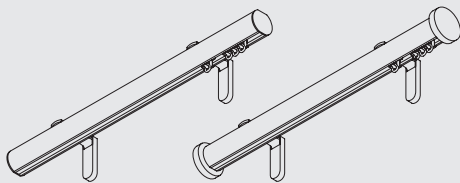

Without finials, poles are supplied as standard with flush fitting endcaps 0346 (left). Alternatively, stud endcaps 0707 (right) can be selected at no additional cost.

Finials

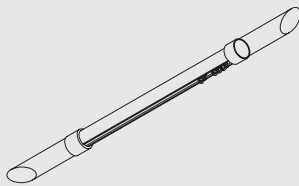

Finials are decorative elements that fit on at the end of the pole.

Please refer to the Metropole brochure for full range details.

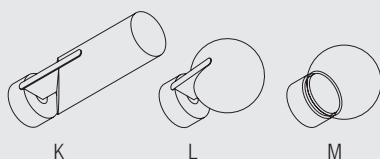
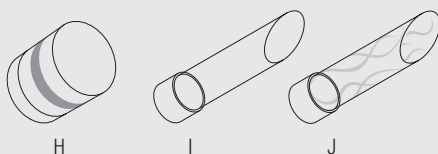
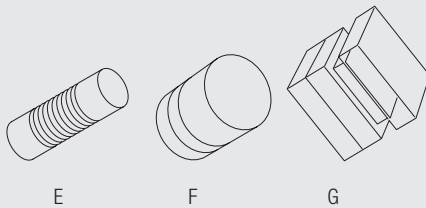
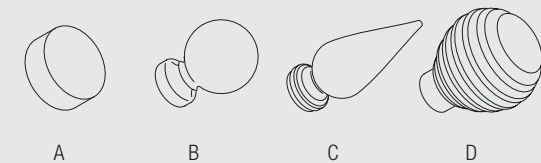

- A: 0873 Design Endcap 20mm
- B: 0556 Ball End 70mm
- C: 0719 Spear 135mm
- D: 0986 Groove Ball 85mm
- E: 0629 Groove Cylinder 85mm
- F: 0901 Strata 65mm
- G: 0886 Crystal Cube 55mm
- H: 0896 Crystal Cylinder 55mm
- I: 0995CL Shard Clear 127mm
- J: 0995ET Shard Etched 127mm
- K: 0311 Fused Barrel 102mm (walnut/oak/matched)
- L: 0324 Fused Ball 60mm (walnut/oak/matched)
- M: 0331 Glass Ball (clear/frosted) 55mm



6130M

Wave Standard curtain heading system

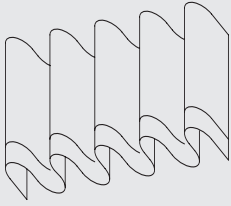

Wave Standard is an exciting contemporary curtain heading system which allows curtains to hang in a continuous wave which is smooth, simple and elegant.

When using the Wave curtain heading system please note the maximum recommended curtain weight is 2.5kg/m or 10kg/m with wave roller glider 6098W.

The Wave standard components are:

6345 Glider Cord 60mm
6346 Glider Cord 80mm
6007 End stop

The items listed below for Enhanced Wave (80mm glider cord only) are all supplied at an additional cost as per the price list.

2255 Adjustable brake
6364 Extension (for use with 6365)
6365 Hanger (for use with 6364)
6366 Carrier for draw rod

Roller gliders must be ordered separately
6098W Wave roller glider 80mm

Optional enhanced components to improve the presentation of the curtain:

3582 Hook
6349 Curtain tape
6363 Iron-on top hemming tape
10075 Lead weight for bottom hem 50gr/m
10076 Fabric weight for side of curtain

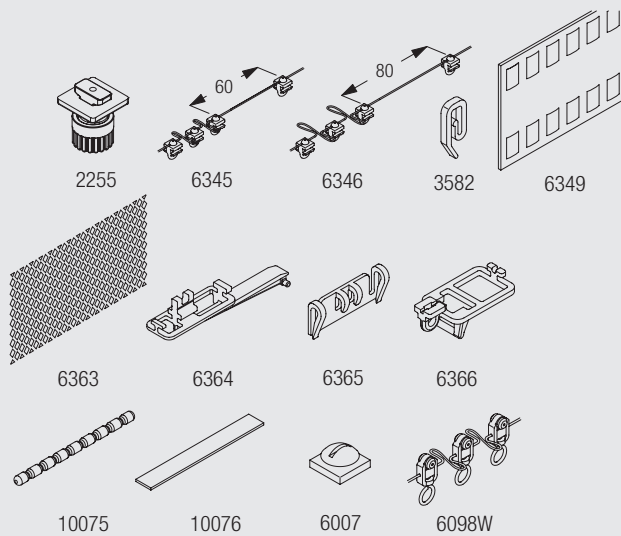

Wave XL curtain heading system

6130M

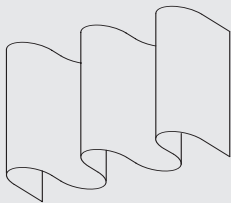

Wave XL is especially designed for high and large application areas through generously designed waves with large cross section dimensions.

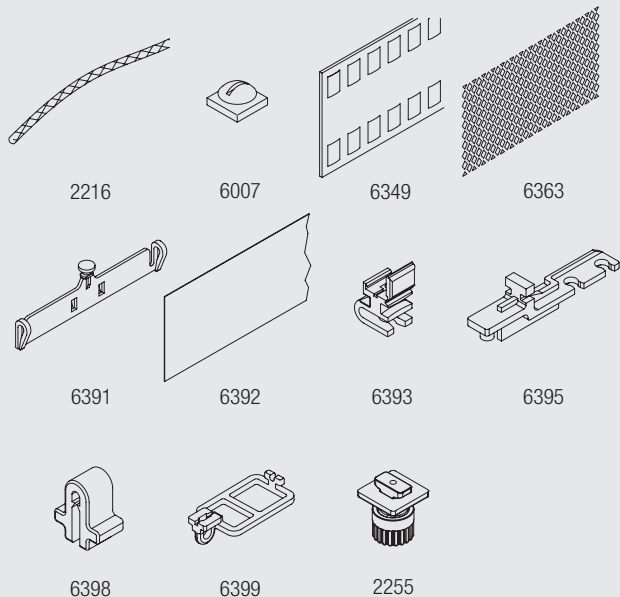

The Wave XL components are:

- 2216 Cord 0.85 mm
- 2255 Adjustable brake
- 6007 End stop
- 6349 Curtain tape
- 6363 Iron tape
- 6391 Hanger
- 6392 Heading film
- 6393 Glider
- 6395 Extension
- 6399 Carrier for draw rod

Additional optional Wave components:

- 6398 Clip

Fitting Information

Bracket positioning when using standard brackets 3134-3136

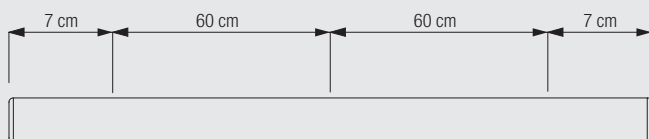

Fitting of tracks to brackets

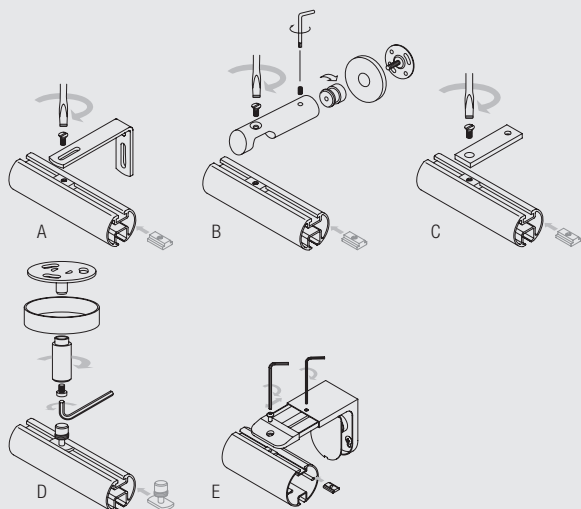

- A: Using brackets 3134/2 - 3136/2
- B: Using pillar bracket 0674C: Using midial bracket 0797A
- D: Using top fix bracket 0335
- E: Using maxi bracket 0334



6130M

Fitting bent tracks

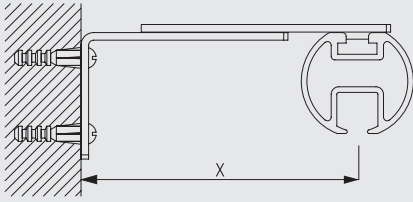

Note: all bent Metropole systems are supplied with adjustable bracket 0537 as standard.

Fitting Options

Wall fix with brackets 3134/2-36/2

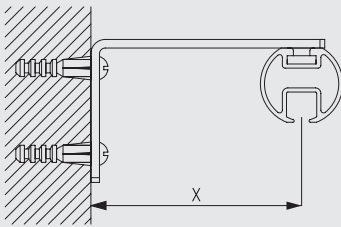

	X (mm)
3134/2	52
3135/2	72
3136/2	92

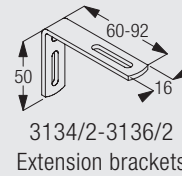

3134/2-3136/2
Extension brackets

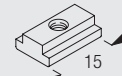

6141
Track insert (uses
screw 0798)

Ceiling fix with support 6138P

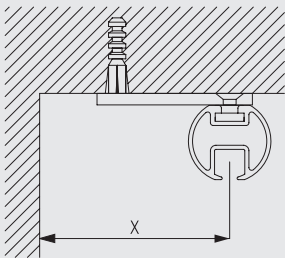

X (mm)
80

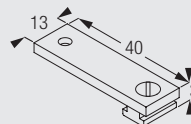

6138p
Ceiling support set
(3mm)



6130M

The final distances may be outside of the recommendations above depending on curtain make-up and any obstructions.

Min. distance from wall when using Wave XL: 220mm.

Wall fix with adjustable bracket 0537

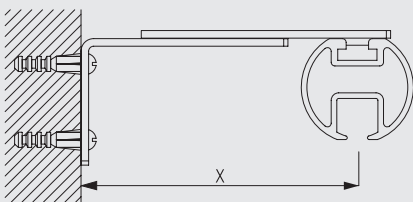

X (mm)
80-100

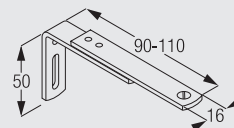

0537
Adjustable bracket

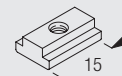

6141
Track insert (uses
screw 0798)

Note: all bent Metropole systems are supplied with adjustable bracket 0537 as standard.

Wall fix with Pillar bracket 0674

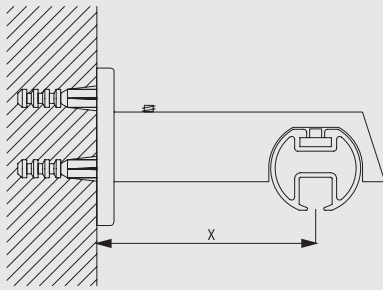

	X (mm)
0674	95

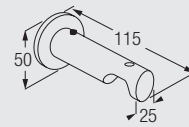

0674
Pillar bracket (30 mm poles only)

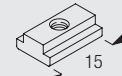

6141
Track insert (uses screw 0798)

Ceiling fix with top fix bracket 0335

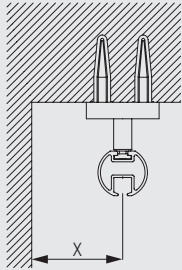

	X (mm)
0335	50

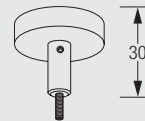

0335
Top fix bracket

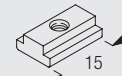

6141
Track insert (uses screw 0798)

Wall fix with maxi adjustable bracket 0334

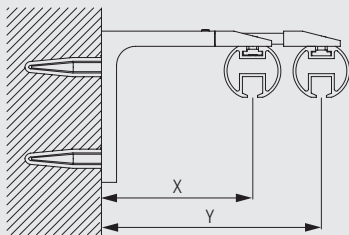

	X (mm)	Y (mm)
0334	80	100

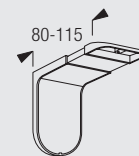

0334
Maxi adjustable bracket

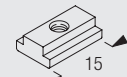

6141
Track insert (uses screw 0798)



6130M

Standard Accessories

Parts

0346	Flush endcap (30mm)		0537	Adjustable bracket	
3133	Bracket cover (60mm)		6065	Twist eye endstop	
6103	Profile		6141	Track insert (uses screw 0798)	
6143	Glider 6144 in strip form		6784	Machine screw (for 6141 insert)	
3134/2	Pole extension bracket (60mm - all colours)				

Optional Accessories

Parts

0901 (30 mm)

Strata



0324

Fused ball (30mm)



0334

Maxi adjustable bracket



0556

Ball end finial (30 mm)



0674

Pillar bracket (30 mm poles only)



0719

Spear finial



0873

Design Endcap 30mm



0896

Crystal cylinder (30mm)



6283

Roller glider



0797A

Midial bracket



3136/2

Pole extension bracket (100mm - all colours)



0995CL

Shard Clear (30mm)



0311

Fused barrel (30mm)

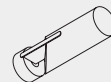

0331

Glass ball (30mm)



0335

Top fix bracket



0629

Groove Cylinder (30mm)

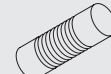

0707

End cover (30mm)



0770

Finial connecting bracket

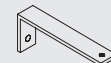

0886

Crystal cube (30mm pole)



0986

Groove Ball (30mm)



6635

Internal connecting bridge assembly

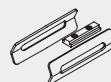

3135/2

Pole extension bracket (80mm - all colours)



6138p

Ceiling support set (3mm)



0995ET

Shard Etched (30mm)

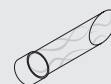

Wave Accessories

2216

Cord



3582

Hook



6345

Wave glider cord (60mm)



6349

Curtain tape



2255

Adjustable brake



6007

Endstop



6346

Wave glider cord (80mm)



6363

Top hemming tape



6130M

6364	Extension		6365	Hanger	
6366	Wave carrier for draw rod		6391	Hanger	
6392	Heading film		6393	Glider	
6395	Extension		6398	Clip	
6399	Carrier for Draw rod		10075	Lead weight 50 gr/m	
10076	Fabric weight		6098W	Wave roller glider cord (80mm)	



www.silentgliss.co.uk

www.silentglissglobal.com

Silent Gliss Ltd
Pyramid Business Park
Poorhole Lane
Broadstairs
Kent
CT10 2PT
Great Britain

Tel: +44 (0) 1843 863571
Fax: +44 (0) 1843 864503
info@silentgliss.co.uk

Silent Gliss Global Ltd
Pyramid Business Park
Poorhole Lane
Broadstairs
Kent
CT10 2PT
Great Britain

Tel: +44 (0) 1843 874250
Fax: +44 (0) 1843 874457
info@silentglissglobal.com