

Cord Operated Curtain Pole System

Silent Gliss® 6160M Metropole

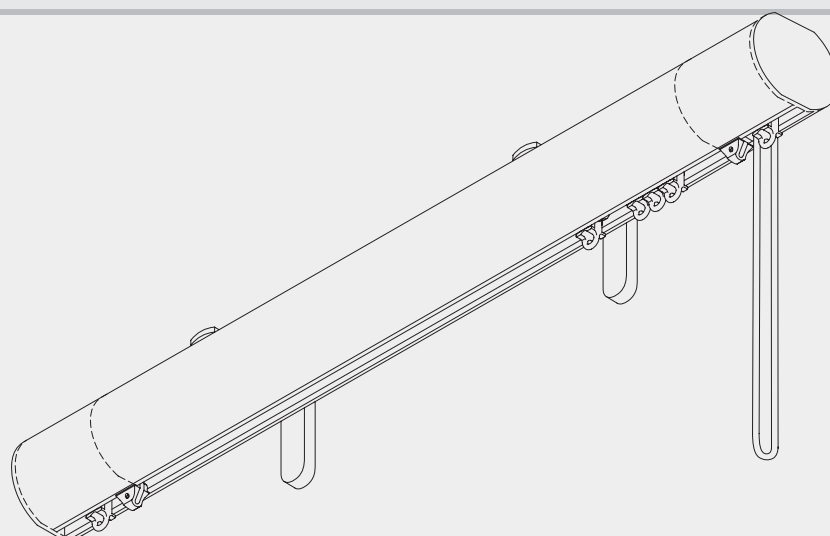

Product Information

- Cord operated system for domestic and contract applications
- 6160M can be bent for bay windows etc
- For light to medium weight curtains
- Made to measure
- Choice of 7 different finishes - anodised silver, black, white, steel grey, taupe, antique bronze and oak effect
- Accessorised with matching endsets and coordinated or matching brackets/bracket covers
- A selection of finials are available
- Easy fit with wall and ceiling brackets
- Suitable for use with Wave Standard and Wave XL curtain heading systems
- Maximum profile length 6m (oak effect 5m)



6160M

Profile, Bending and Specification Information

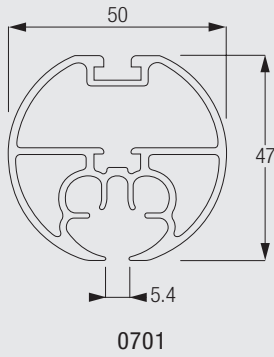

 Standard radius 600mm
(Incl. Wave XL)

Note: It is important to observe the minimum bending radius for Wave XL. The system will not function with a smaller radius.

Specification Information - for download refer to www.silentgliss.co.uk (password required).

Silent Gliss 6160M curtain track, cord drawn, aluminium, assembled with gliders 6143 10/m. Metal overlap arm 6003, cord set 0347, cord 3091, end caps 0350, pilot 6534 and endstops 6065. Face fix with bracket 0537/ 3134/2-36/2/ 0334/top fix with bracket 6138P2/ 0335 each screwed to timber/plugged and screwed to block/concrete at 600mm centres. Finished in black, silver, steel grey, antique bronze, taupe, white and oak effect.

How to Measure

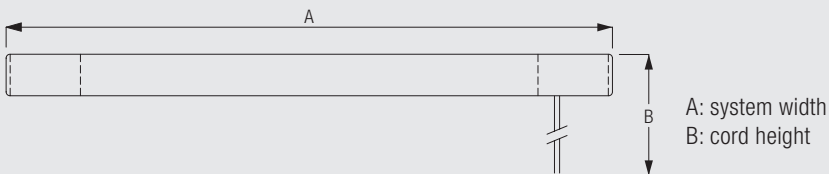

Stack size calculation Wave Standard

6160M

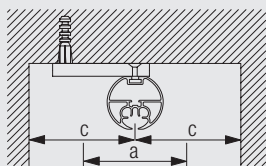
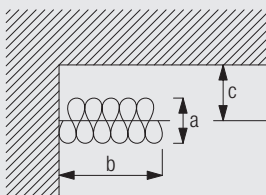

a = Stack depth
b = Stack size
c = Min. distance

Glider-cord spacing	Curtain hook spacing	Approx. curtain fullness	Stack depth (a)	Stack width (b)	Min distance (c)
6	10	2.1	10	23 per metre of track + endpiece	8
6	12	2.3	12	23 per metre of track + endpiece	9
8	14	2.1	14	18 per metre of track + endpiece	10
8	16	2.3	16	18 per metre of track + endpiece	11

Wave standard with roller gliders

Glider-cord spacing	Curtain hook spacing	Approx. curtain fullness	Stack depth (a)	Stack width (b)	Min distance (c)
8	14	2.1	14	21 per metre of track + endpiece	10
8	16	2.3	16	21 per metre of track + endpiece	11

(dimensions in cm)

Note: Minimum distance (c) allows a standard 3cm clearance (front and back).

Stack size calculation Wave XL

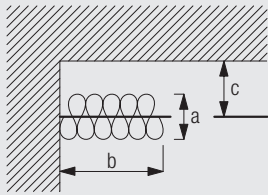

a = Stack depth 35cm
 b = Stack size
 c = Min. distance 22cm

System width		77-107	108-143	144-179	180-215	216-251	252-287	288-323	324-359	360-395
	b	28	33	38	43	48	53	58	63	68
System width		396-431	432-468	469-503	504-539	540-575	576-600			
	b	73	78	83	88	93	98			
System width		154-217	218-289	290-361	362-433	434-505	506-577	578-600		
	b	28	33	38	43	48	53	58		

(dimensions in cm)

System Dimensions

Maximum curtain weights

Standard Application with Glider

	1 m	2 m	3 m	4 m	5 m	6 m
	9	9	8	8	7	7
	10	10	9	9	8	8
	7	7	6	6	5	5
	8	8	7	7	6	6
	4	4	3	3	2	2
	5	5	4	4	3	3
	3	3	2	2	1	1
	4	4	3	3	2	2

(kg max.)

Standard Application with Roller/ Wave Roller

	1 m	2 m	3 m	4 m	5 m	6 m
	12	11	11	11	10	10
	13	13	12	11	11	10
	9	8	8	8	7	7
	10	9	9	9	8	8
	6	5	5	5	4	4
	7	6	6	6	5	5
	5	4	4	4	3	3
	6	5	5	5	4	4

(kg max.)

Wave and Wave XL maximum curtain weights

Maximum curtain weight when using Wave / Wave XL curtain heading is 2.5kg/m unless the weight in the above left table is less in which case follow table. A greater weight may be achieved using wave roller glider 6098W (refer to table above right).

Design Options

Endcaps

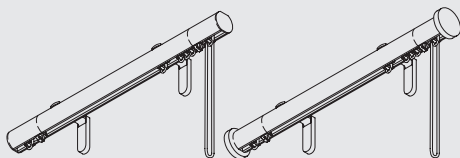

Without finials, poles are supplied as standard with flush fitting endcaps 0350 (left). Alternatively, stud endcaps 0714 (right) can be selected at no additional cost.

Finials

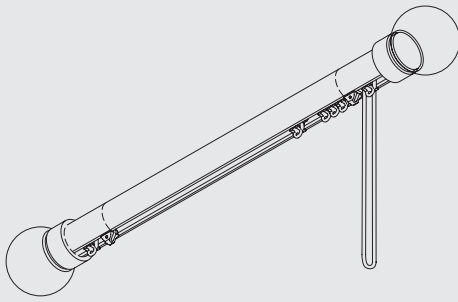

Finials are decorative elements that fit on at the end of the pole.

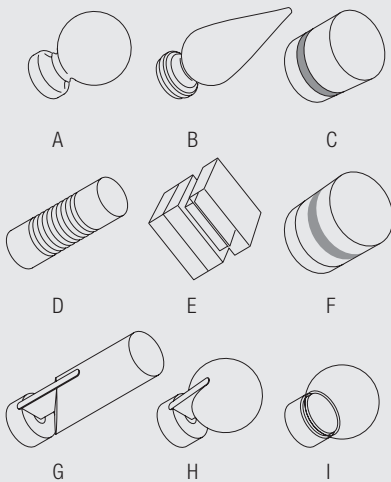

- A: 0717 Ball End 125mm
- B: 0718 Real Wood Spear 150mm
- C: 0697 Strata 65mm
- D: 0630 Groove Cylinder 125mm
- E: 0898 Crystal Cube 55mm
- F: 0899 Crystal Cylinder 55mm
- G: Fused Barrel 121mm (walnut/oak/matched)
- H: Fused Ball 81mm (walnut/oak/matched)
- I: Glass Ball (clear/frosted) 70mm

Please refer to the Metropole brochure for full range details.

Wave Standard curtain heading system



6160M

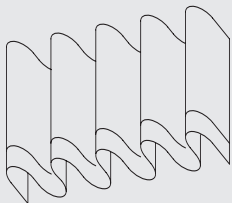

Wave Standard is an exciting new contemporary heading system which allows curtains to hang in a continuous wave which is smooth, simple and elegant.

When using the Wave curtain heading system please note the maximum recommended curtain weight is 2.5kg/m. A greater weight may be achieved using wave roller glider 6098W (refer to 'System Dimensions').

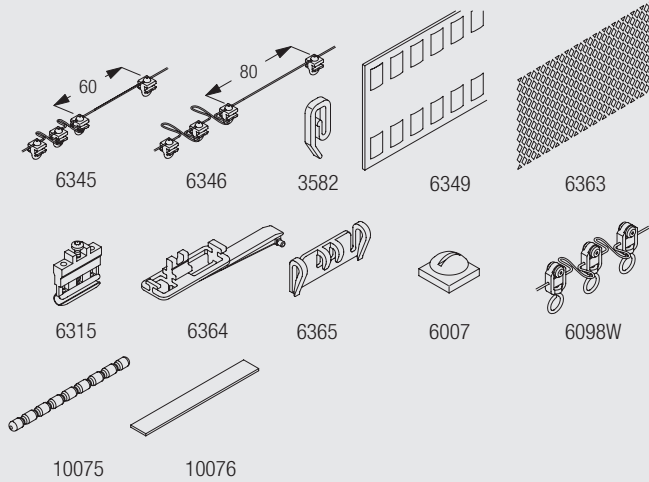

The Wave standard components are:

- 6345 Glider Cord 60mm
- 6346 Glider Cord 80mm
- 6007 End stop

The items listed below for Enhanced Wave (80mm glider cord only) are all supplied at an additional cost as per the price list.

- 2255 Adjustable brake
- 6364 Extension (for use with 6365)
- 6365 Hanger (for use with 6364)
- 6366 Carrier for draw rod

Roller gliders must be ordered separately
6098W Wave roller glider 80mm

Optional enhanced components to improve the presentation of the curtain:

- 3582 Hook
- 6349 Curtain tape
- 6363 Iron-on top hemming tape
- 10075 Lead weight for bottom hem 50gr/m
- 10076 Fabric weight for side of curtain

Wave XL curtain heading system

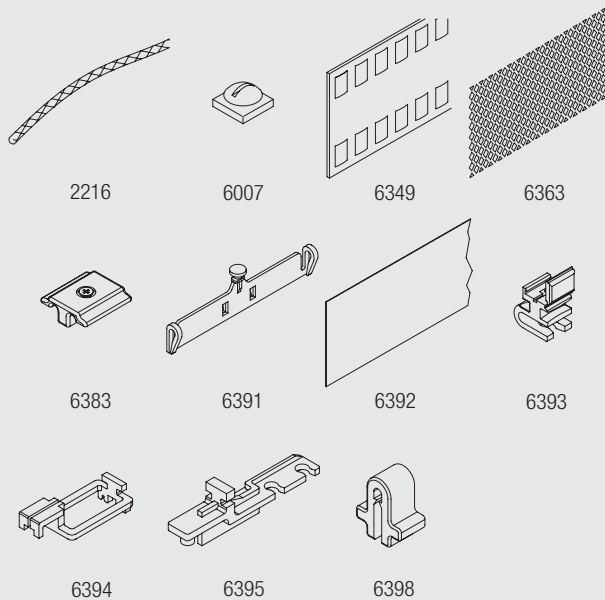
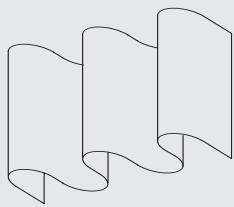

Wave XL is especially designed for high and large application areas through generously designed waves with large cross section dimensions.

The Wave XL components are:

- 2216 Cord 0.85mm
- 6007 End stop
- 6349 Curtain tape
- 6363 Iron-on tape
- 6383 Limit stop
- 6391 Hanger
- 6392 Heading film
- 6393 Glider
- 6394 Carrier
- 6395 Extension

Additional optional Wave XL components:

- 6398 Clip



6160M

Fitting Information

WARNING

Young children can be strangled by loops in pullcords, chains, tapes and inner cords that operate the product. To avoid strangulation and entanglement, keep cords out of the reach of young children. Cords may become wrapped around a child's neck. Move beds, cots and furniture away from window covering cords. Do not tie cords together. Make sure cords do not twist to create a loop.

Bracket positioning using Maxi Bracket 0334 (standard)

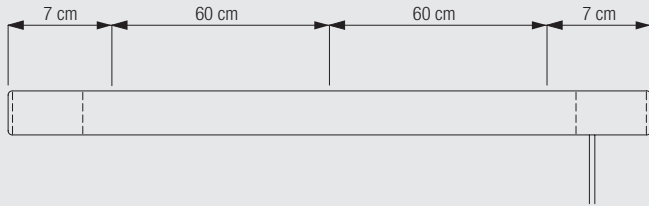

An additional bracket may be required near the 'cord-end' of the system if the system is carrying very heavy curtains.

Fitting of track to bracket

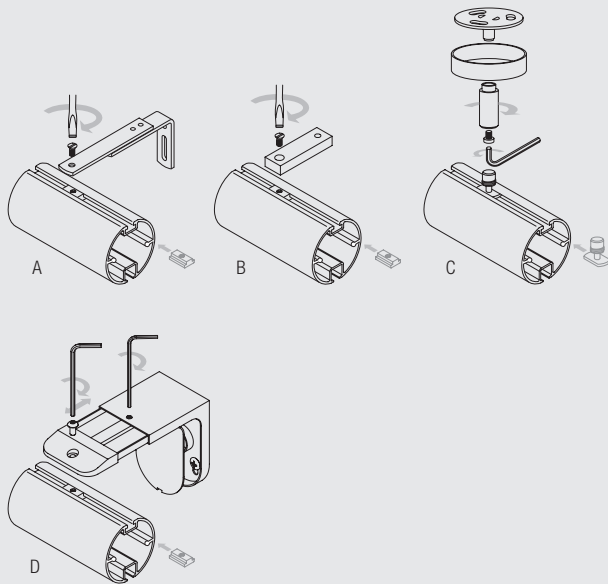

- A: Using adjustable bracket 0537
- B: Using ceiling support 6138P
- C: Using top fix bracket 0335
- D: Using maxi adjustable bracket 0334

All 50mm Metropole are supplied with Maxi bracket 0334 as standard unless otherwise specified.

Fitting Options

Wall fix with adjustable brackets 0537

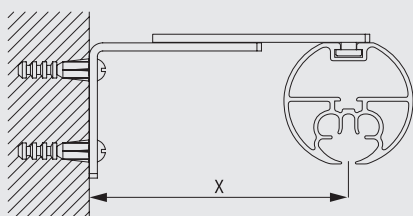

	X (mm)
0537	80-100

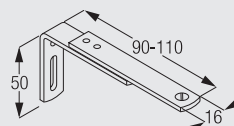

0537
Adjustable bracket

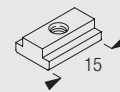

6141
Track insert (uses
screw 0798)

Wall fix with brackets 3134/2-3136/2

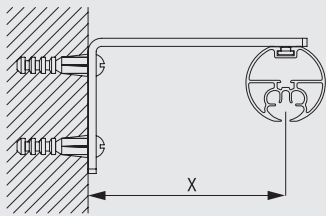

	X (mm)
3134/2	52
3135/2	72
3136/2	92

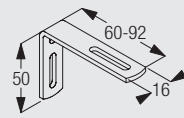

3134/2
Pole extension
bracket (60mm - all
colours)

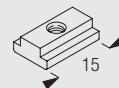

6141
Track insert (uses
screw 0798)

Ceiling fix with 6138P2

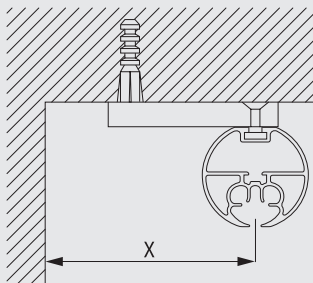

	X (mm)
6138P2	80

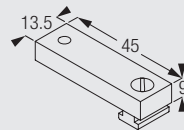

6138P2 (9mm)
Ceiling support set

The final distances may be outside of the recommendations above depending on curtain make-up and any obstructions.

Min. distance from wall when using Wave XL: 220mm.

Ceiling fix with top fix bracket 0335

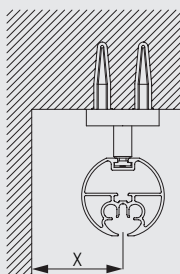

	X (mm)
0335	50

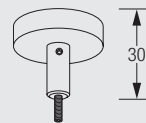

0335
Top fix bracket

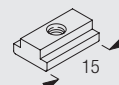

6141
Track insert (uses
screw 0798)

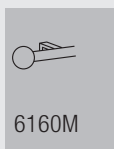

6160M

The final distances may be outside of the recommendations above depending on curtain make-up and any obstructions.

Min. distance from wall when using Wave XL: 220mm.

Wall fix with maxi adjustable bracket 0334

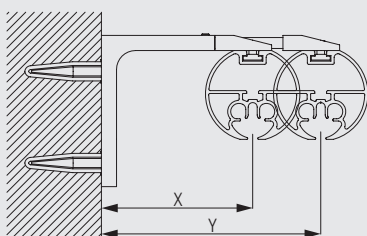

X (mm)	Y (mm)
80	100

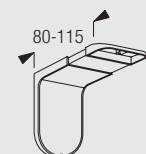

0334
Maxi adjustable
bracket

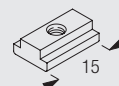

6141
Track insert (uses
screw 0798)

Ceiling fix with top fix bracket 0335

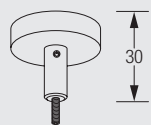
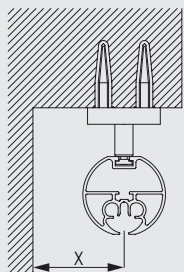



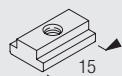





0335
Top fix bracket

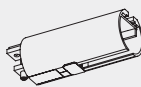

6141
Track insert (uses
screw 0798)

Standard Accessories

Parts

0334	Maxi adjustable bracket		0347	Cording set (50mm)	
0350	Flush endcap (50mm)		0701	Profile 50mm (corded)	
3091	Cord		3133	Bracket cover (60mm)	
6065	Twist eye endstop		6143	Glider 6144 in strip form	
6784	Machine screw (for 6141 insert)		10400	Safety Cord Retainer	



6160M

Optional Accessories

Parts

6138P2 (9mm)	Ceiling support set		0315	Fused barrel (50mm)	
0327	Fused ball (50mm)		0335	Top fix bracket	
0537	Adjustable bracket		0630	Groove Cylinder (50mm)	
0630	Groove Cylinder (50mm)		0697	Strata (50mm)	
0717	Ball end finial (50mm pole)		0717	Ball end finial (50mm pole)	
0718	Spear finial (50mm pole)		0898	Crystal Square (50mm)	

Supplied by

SG-S SILENTGLISS SPARES
SILENTGLISS SYSTEMS

www.sg-s.co.uk email: sales@sg-s.co.uk tel: 01395 232528

0898	Crystal Square (50mm)		0899	Crystal Cylinder (50mm)	
0899	Crystal Cylinder (50mm)		6007	Endstop	
6283	Roller glider		3134/2	Pole extension bracket (60mm - all colours)	
3135/2	Pole extension bracket (80mm - all colours)		3136/2	Pole extension bracket (100mm - all colours)	

Sets

0646	Intermediate pulley, containing:	0700	Profile 50mm	1	
		0645	Intermediate pulley cover	1	
		3810	Pulley	2	
		6164	Clamping piece	1	
		6169	Holder	1	

Wave Accessories

2216	Cord		3582	Hook	
6007	Endstop		6315	Pilot runner	
6345	Wave glider cord (60mm)		6346	Wave glider cord (80mm)	
6349	Curtain tape		6363	Top hemming tape	
6364	Extension		6365	Hanger	
6383	Limit stop		6391	Hanger	
6392	Heading film		6393	Glider	
6394	Carrier		6395	Extension	

6160M

6398 Clip



10075 Lead weight 50 gr/m

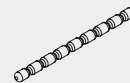

10076 Fabric weight



6098W Wave roller glider cord (80mm)

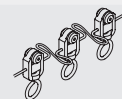

Useful Measurements

6063 Metal overlap arm

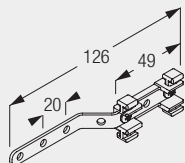

6160M

Supplied by

SG-S SILENTGLISS SPARES
SILENTGLISS SYSTEMS

www.sg-s.co.uk email: sales@sg-s.co.uk tel: 01395 232528



www.silentgliss.co.uk

www.silentglissglobal.com

Silent Gliss Ltd
Pyramid Business Park
Poorhole Lane
Broadstairs
Kent
CT10 2PT
Great Britain

Tel: +44 (0) 1843 863571
Fax: +44 (0) 1843 864503
info@silentgliss.co.uk

Silent Gliss Global Ltd
Pyramid Business Park
Poorhole Lane
Broadstairs
Kent
CT10 2PT
Great Britain

Tel: +44 (0) 1843 874250
Fax: +44 (0) 1843 874457
info@silentglissglobal.com