

Cord Operated Curtain Track System

Silent Gliss® 6350 Cord Operated Curtain Track

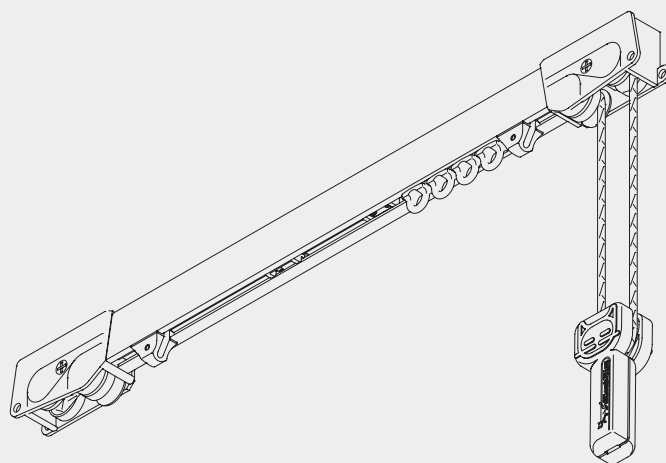

Product Information

- Cord operated curtain track system for contract as well as residential use.
- For medium weight applications (max. 38kg; see weight chart).
- The maximum length of the system is 12m. It depends on fabric weight and application.
- Strong profile with concealed channel.
- Bendable up to a minimum radius of 20cm.
- Fixing to wall or ceiling.
- Standard colours: anodised aluminium.
- Custom paint colours on application.
- Standard length of the profiles 6m.
- Large and attractive fabric offer.



6350

Profile, bending and Specification Information

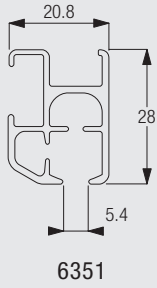

Minimum radius 20cm.

Specification Guide

Silent Gliss 6350 cord operated aluminium curtain track, assembled complete with roller gliders 6283 at 10/metre. Cord-guide/return set 6358, overlap arm 6063 and cord 3093, (cord drop 150cm R.H.S.). Face/top fixed with nylon bracket 3630 at 600mm centres.

How to measure

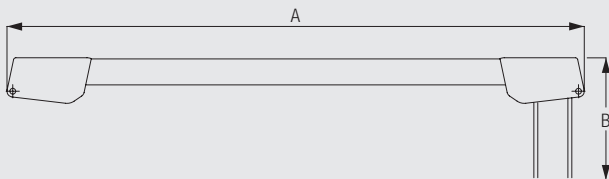

A: system width
B: cord height

System Dimensions



12 m



38 kg



6350

Max. Curtain Weight Chart (with 6283 roller)

	2 m	4 m	6 m	8 m	10 m	12 m
	34	33	31	29	27	25
	39	37	35	33	32	30
	27	24	21	18	15	-
	32	29	26	23	20	-
	22	20	18	15	13	-
	27	24	21	18	15	-

(kg max.)

Fitting Information

Bracket Positioning

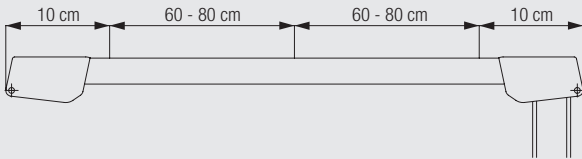

Fixing with universal click-in bracket

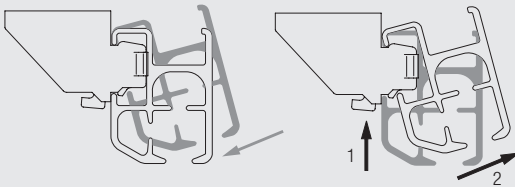

Applicable with 3603/3630/3655/3660

Installation: Roll track onto bracket in direction indicated
Removal: 1. Press to release 2. Rotate forward for removal

Fitting Options

Ceiling fitting with bracket 3603

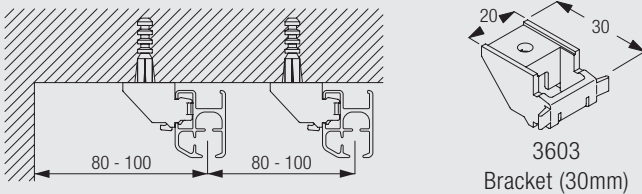

Wall fitting with brackets 3630, 3655 and 3660

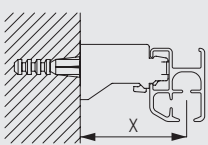

	X (mm)
3630	42
3655	57
3660	72

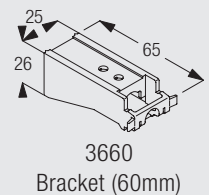
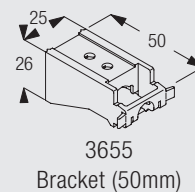
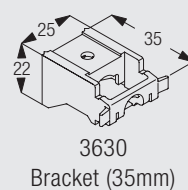

6350

Wall fitting with extension brackets 3134-3139 and bracket 3603

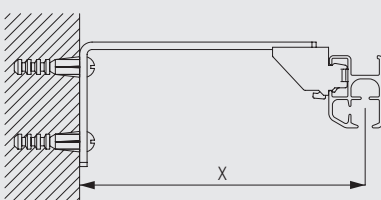

	X (mm)
3134	79
3135	99
3136	119
3137	139
3138	169
3139	219

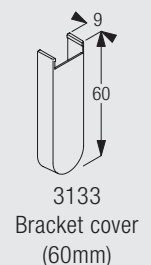
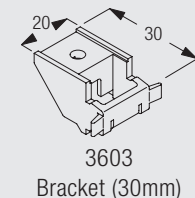
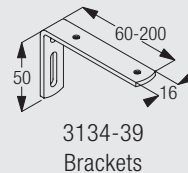

Wall fitting with bracket 3239 and bracket 3603 (for heavy applications)

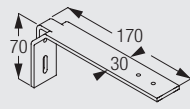
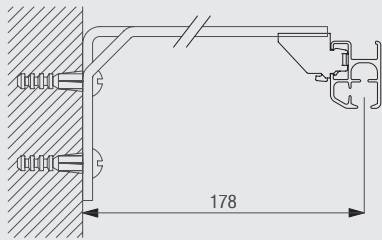

3239
Bracket (170mm)

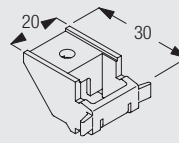

3603
Bracket (30mm)

Wall fitting with bracket support 3271 and brackets 3272-3274 and 3603 (variable distance)

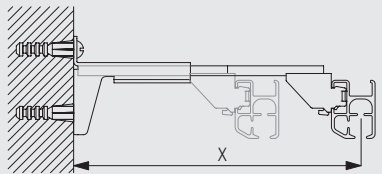

	X (mm)
3271/3272	87-122
3271/3273	122-137
3271/3274	137-172

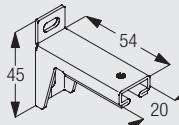

3271
Bracket support

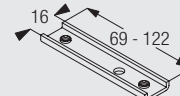

3272-74
Bracket plates

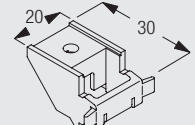

3603
Bracket (30mm)

Standard Accessories

3040 Cord weight



3093 Cord (ø 4mm)



3630 Bracket (35mm)

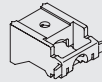

6063 Overlap arm



6086 Spring stop



6283 Roller



6351 Profile



6350

Sets

6358 Guide return set for straight and bend applications, containing

6354 Pilot runner

2



6355 Guide left

1

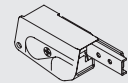

6356 Guide right

1

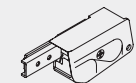

Optional Accessories

3134 Bracket (60mm)



3135 Bracket (80mm)

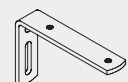



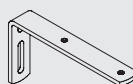



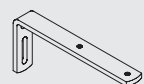

3136 Bracket (100mm)

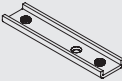
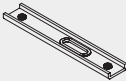
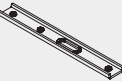

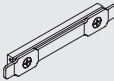
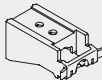
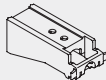
3137 Bracket (120mm)





3138	Bracket (150mm)		3139	Bracket (200mm)	
3271	Bracket support		3272	Bracket plate (69mm)	
3273	Bracket plate (92mm)		3274	Bracket plate (122mm)	
3603	Bracket (30mm)		3620	Connecting bridge	
3655	Bracket (50mm)		3660	Bracket (60mm)	
6065	Eye endstop		6094	Roller	
6098	Roller		6288	Overlap arm	

Sewing Accessories

3582	Hook		6146	Hook	
------	------	--	------	------	--

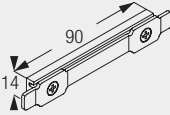
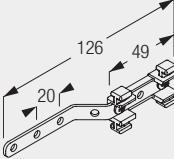
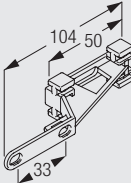
Useful Measurements

3620	Connecting bridge		6063	Overlap arm	
6288	Overlap arm				 6350