

## Hand Operated Curtain Track System

# Silent Gliss® 6820

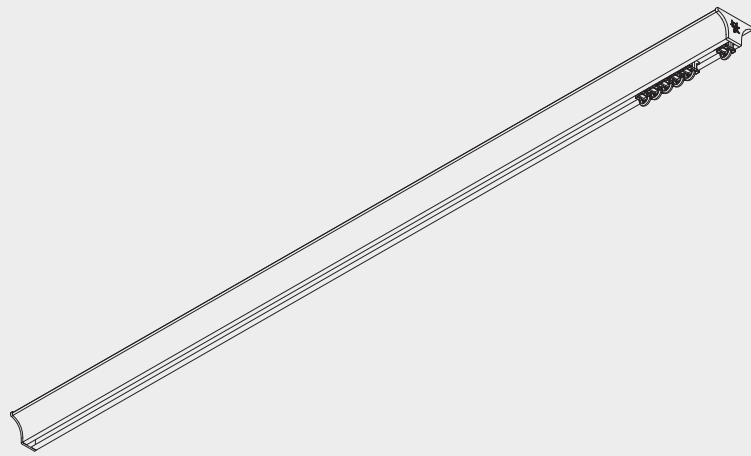

### Product Information

- Operation: hand drawn
- Range: M
- Fitting: ceiling
- Colours: white
- Shape: funnel
- 2C glider technology
- Wave compatible
- Bendable



6820

## Profile and Bending Information

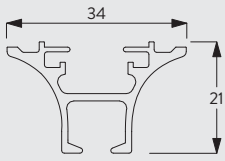

6821

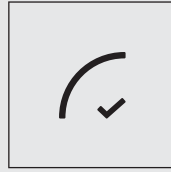

Radius: >27 cm

## How To Measure

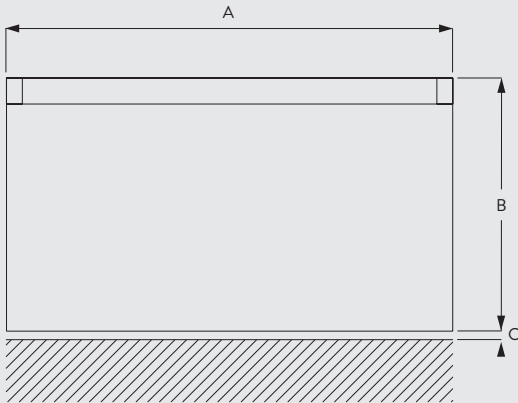

A: System width  
B: System height  
C: Distance between floor and fabric

## System Dimensions

6820



10 kg

## System Options

### Wave Curtain Heading System

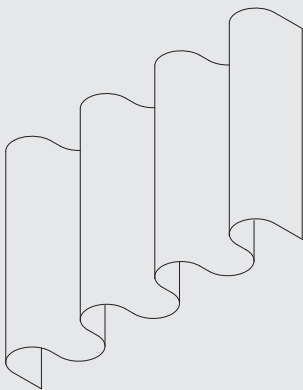

The Wave standard components are:

- 11303 Wave 2C Glider Cord 60mm
- 11302 Wave 2C Glider Cord 80mm
- 6007 End stop
- 6315 Pilot runner

The items listed below for Enhanced Wave (80mm glider cord only) are all supplied at an additional cost as per the price list.

- 2255 Adjustable brake
- 6364 Extension (used with 6365)
- 6365 Hanger (used with 6364)
- 6366 Carrier for draw rod

Roller Gliders must be ordered separately  
6099 Wave roller glider 80mm

Optional components to improve the presentation of the curtain:

- 3582 Hook
- 6349 Curtain tape
- 6363 Iron-on top hemming tape
- 10075 Lead weight for hem of curtain 50gr/m
- 10076 Fabric weight for side edge of curtain

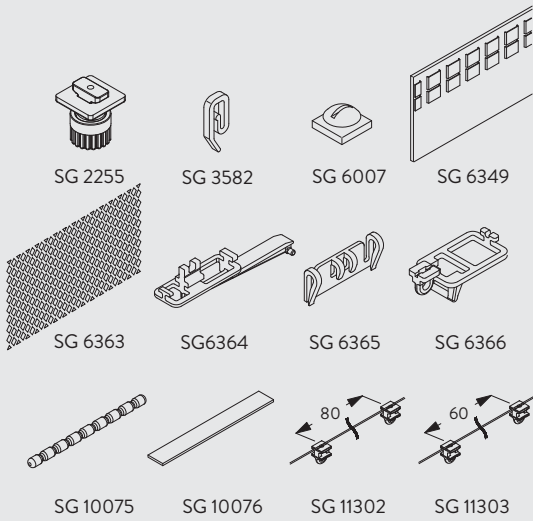

## Fitting Information

### Fixing Points

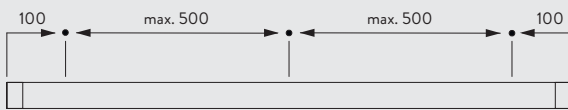

## Fitting Options

### Ceiling fitting with clip SG 11236

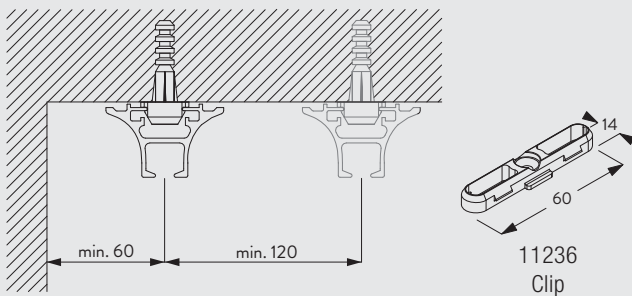

## Standard Accessories

6065 Twist eye endstop



6821 Profile Funnel



6823 End cover



11236 Clip

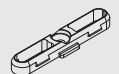

11301 2C glider 11300 on strip (x20)



### Optional Accessories

3582 Hook



3599 Hook



3802 Connecting bridge



6007 Endstop



6053 Spring stop



6086 Spring stop



6094 Roller glider with hook



6098 Roller glider with eye



6146 Hook



6283 Roller glider



10430 Draw rod with hook, 50cm



10431 Draw rod with hook, 75cm



10432 Draw rod with hook, 100cm



10433 Draw rod with hook, 125cm



10434 Draw rod with hook, 150cm



### Wave Accessories

2255 Adjustable brake



6099 Wave roller glider cord (80mm)



6349 Curtain tape



6363 Top hemming tape



6364 Extension

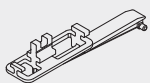

6365 Hanger



6366 Wave carrier for draw rod

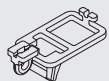

10075 Lead weight 50 gr/m

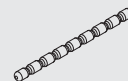

10076 Fabric weight



11302 Wave 2C glider cord 80 mm



11303 Wave 2C glider cord 60 mm

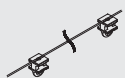

6820

Supplied by



[www.sg-s.co.uk](http://www.sg-s.co.uk) email: [sales@sg-s.co.uk](mailto:sales@sg-s.co.uk) tel: 01395 232528

[www.silentgliss.co.uk](http://www.silentgliss.co.uk)

[www.silentglissglobal.com](http://www.silentglissglobal.com)

Silent Gliss Ltd  
Pyramid Business Park  
Poorhole Lane  
Broadstairs  
Kent  
CT10 2PT  
Great Britain

Tel: +44 (0) 1843 863571  
Fax: +44 (0) 1843 864503  
[info@silentgliss.co.uk](mailto:info@silentgliss.co.uk)

Silent Gliss Global Ltd  
Pyramid Business Park  
Poorhole Lane  
Broadstairs  
Kent  
CT10 2PT  
Great Britain

Tel: +44 (0) 1843 874250  
Fax: +44 (0) 1843 874457  
[info@silentglissglobal.com](mailto:info@silentglissglobal.com)