

## Hand Operated Curtain Track System

# Silent Gliss® 6970

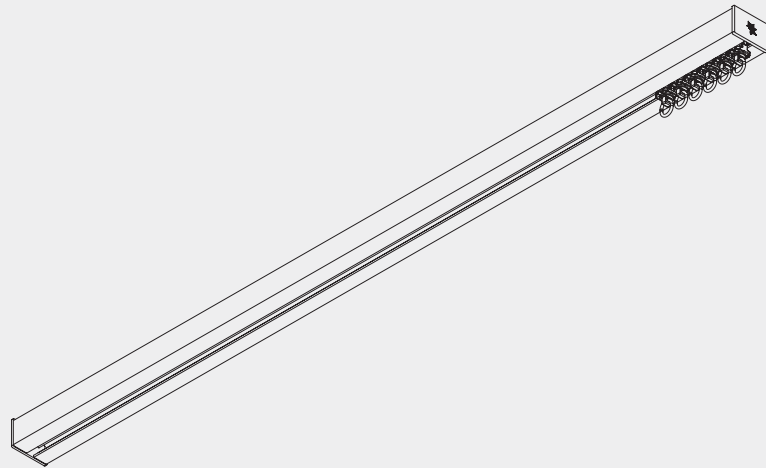

### Product Information

- Operation: hand drawn
- Range: L
- Fitting: ceiling, wall, recess
- Colours: white
- Shape: square
- 2C glider technology
- Wave compatible
- Bendable (including recess profile)



6970

## Profile and Bending Information

### Profile

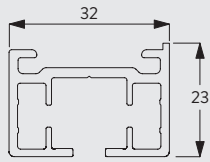

10850



Radius: >25 cm

### Recess profile

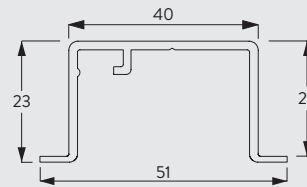

10862

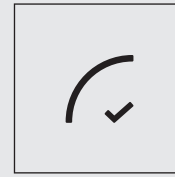

Radius: >50 cm  
Max. radius: 75 cm

### Specification text:

Silent Gliss SG 6970 Hand Operated Curtain Track System. Comprises aluminium profile SG 10850 supplied made to measure available in silver anodised or powder coated in white. Supplied as standard with 2C roller gliders SG 10840 at 10/m, 2 end covers SG 11235 and 2 end stops SG 6007. Top fixed with fixing clamp SG 3004 at max. 500mm centres. Optional top fix with SG 3041 bracket or direct top fix with mounting plate SG 10865 and profile protector SG 7002. Wall fix with SG Smart Fix brackets SG 11201-11205 and SG 3041 or SG 3004 / SG Square Smart Fix brackets SG 11210-11215 and SG 3041 or SG 3004 / SG Universal Smart Fix brackets SG 11154-11156 and SG 3041 or SG 3004. Recess fix with recess profile SG 10862, recess masks SG 10864 and wedges SG 5118. Silent Gliss Wave option is available using 60mm glider cord 10869 / 80mm glider cord SG 10852.

## How To Measure

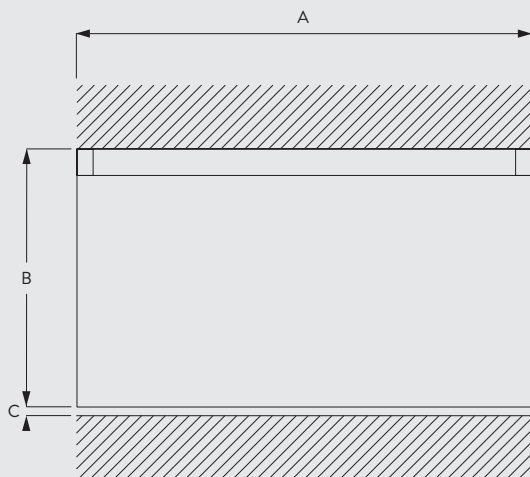

A: System width  
B: System height  
C: Distance between floor and fabric

## System Options

### Wave Curtain Heading System

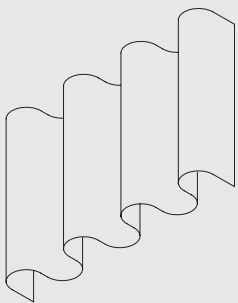

Supplied by

**SG-S** | Silent Gliss Spares  
Silent Gliss Systems

www.sg-s.co.uk email: sales@sg-s.co.uk  
Tel: 0330 1272002 - 01395 232528

Silent Gliss®

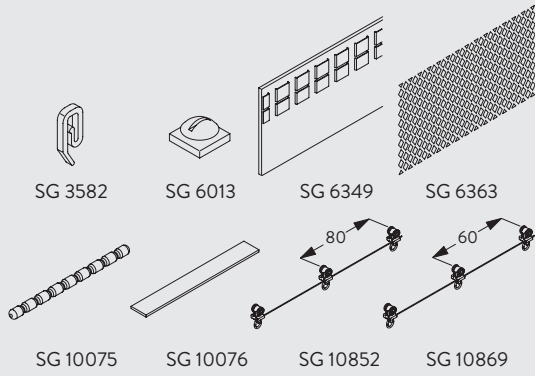

The Wave standard components are:

- 10869 Wave 2C Glider Cord 60mm
- 10852 Wave 2C Glider Cord 80mm
- 6007 End stop

Optional components to improve the presentation of the curtain:

- 3582 Hook
- 6349 Curtain tape
- 6363 Iron-on top hemming tape
- 10075 Lead weight for hem of curtain 50gr/m
- 10076 Fabric weight for side edge of curtain

## Fitting Information

### Fixing Points

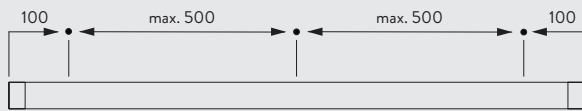

## Fitting Options

### Ceiling fitting with direct mounting

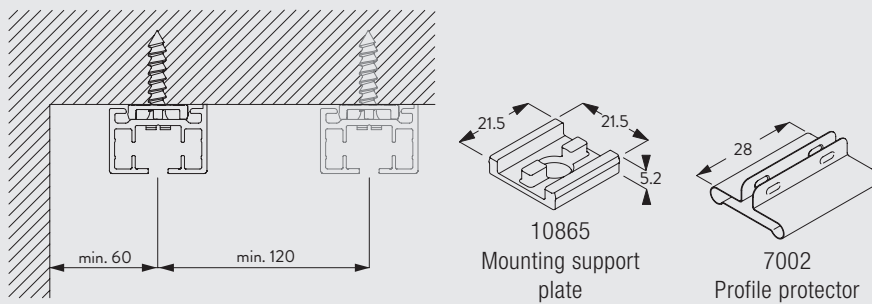

### Ceiling fitting with clamp SG 3004

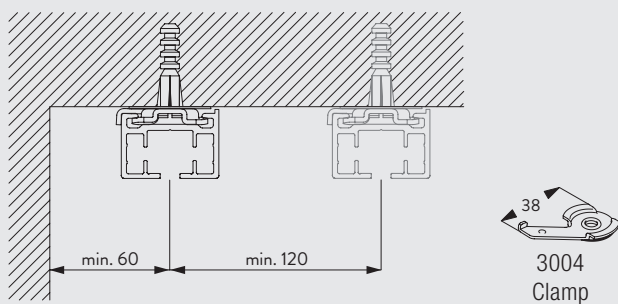

6970

### Wall fitting with Smart Fix SG 11200-11205 and bracket SG 3041



	X (mm)
11200	83
11201	103
11202	123
11203	143
11204	173
11205	223



11200-05  
Smart Fix (60-200 mm)

3041  
Bracket

Brackets threaded for screw M4 x 8

### Wall fitting with Square Smart Fix SG 11210-11215 and bracket SG 3041



	X (mm)
11210	83
11211	103
11212	123
11213	143
11214	173
11215	223





11210-15  
Square Smart Fix  
(60-200 mm)

3041  
Bracket

Brackets threaded for screw M4 x 8

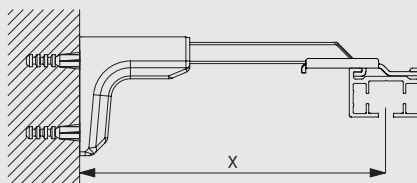
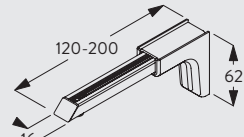
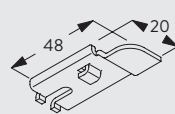
### Wall fitting with Universal Smart Fix SG 11154-11156 and bracket SG 3041





11154-56  
Universal Smart Fix  
(120-200 mm)

3041  
Bracket

Brackets threaded for screw M4 x 8

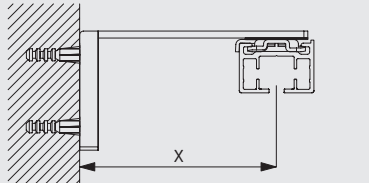
### Wall fitting with Smart Fix SG 11201-11205 and clamp SG 3004

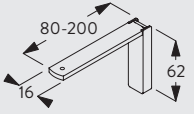
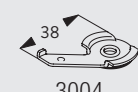

	X (mm)
11201	72
11202	92
11203	112
11204	142
11205	192

11201-05  
Smart Fix (80-200 mm)

3004  
Clamp

Brackets threaded for screw M4 x 8

Supplied by

**SG-S** | Silent Gliss Spares  
Silent Gliss Systems

www.sg-s.co.uk email: sales@sg-s.co.uk  
Tel: 0330 1272002 - 01395 232528

Silent Gliss®

### Wall fitting with Square Smart Fix SG 11211-11215 and clamp SG 3004

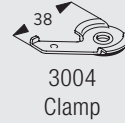
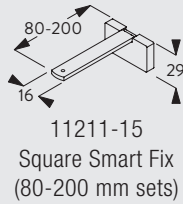
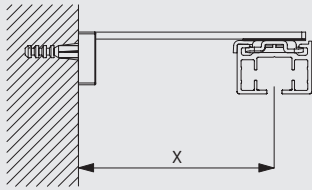

Brackets threaded for screw M4 x 8

### Wall fitting with Universal Smart Fix SG 11154-11156 and clamp SG 3004

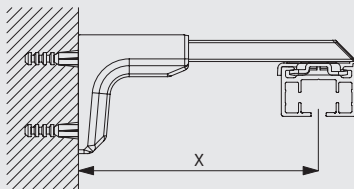

	X (mm)
11154	102-130
11155	132-160
11156	182-210

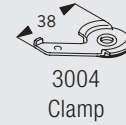
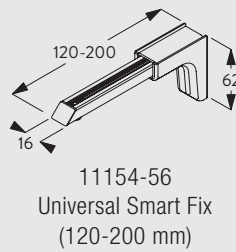

Brackets threaded for screw M4 x 8

### Recess fitting with recess profile SG 10862

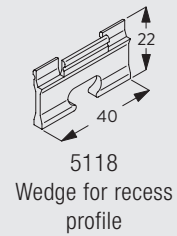
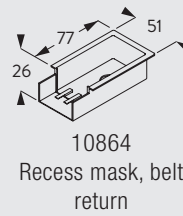
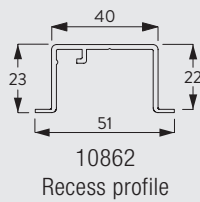
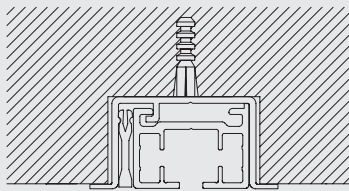

6970

### Standard Accessories

3004 Clamp



6007 Endstop



10840 Two component roller



10850 Profile

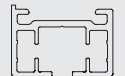

11235 End cover



### Optional Accessories

3582 Hook



5118 Wedge for recess profile



6007 Endstop



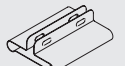

7002 Profile protector



10407	Pan head screw M4x10		10430	Draw rod with hook, 50cm	
10431	Draw rod with hook, 75cm		10432	Draw rod with hook, 100cm	
10433	Draw rod with hook, 125cm		10434	Draw rod with hook, 150cm	
10831	Connecting bridge		10862	Recess profile	
10864	Recess mask, belt return		10865	Mounting support plate	
11154	Universal Smart Fix, 120 mm set		11155	Universal Smart Fix, 150 mm set	
11156	Universal Smart Fix, 200 mm set		11200	Smart Fix, 60 mm set	
11201	Smart Fix, 80 mm set		11202	Smart Fix, 100 mm set	
11203	Smart Fix, 120 mm set		11204	Smart Fix, 150 mm set	
11205	Smart Fix, 200 mm set		11210	Square Smart Fix, 60 mm set	
11211	Square Smart Fix, 80 mm set		11212	Square Smart Fix, 100 mm set	
6970 11213	Square Smart Fix, 120 mm set		11214	Square Smart Fix, 150 mm set	
11215	Square Smart Fix, 200 mm set				

## Wave Accessories

6349	Curtain tape		6363	Top hemming tape	
10075	Lead weight 50 gr/m		10076	Fabric weight	
10852	Wave roller cord (80mm), 6.5mm channel		10869	Wave roller cord (60mm), 6.5mm channel	

Supplied by

**SG-S** | **Silent Gliss Spares**  
**Silent Gliss Systems**  
www.sg-s.co.uk email: sales@sg-s.co.uk  
Tel: 0330 1272002 - 01395 232528

[www.silentgliss.co.uk](http://www.silentgliss.co.uk)

[www.silentglissglobal.com](http://www.silentglissglobal.com)

Silent Gliss Ltd  
Pyramid Business Park  
Poorhole Lane  
Broadstairs  
Kent  
CT10 2PT  
Great Britain

Tel: +44 (0) 1843 863571  
Fax: +44 (0) 1843 864503  
info@silentgliss.co.uk

Silent Gliss Global Ltd  
Pyramid Business Park  
Poorhole Lane  
Broadstairs  
Kent  
CT10 2PT  
Great Britain

Tel: +44 (0) 1843 874250  
Fax: +44 (0) 1843 874457  
info@silentglissglobal.com