

## Motorised Skylight Shading System

# Silent Gliss® 8600

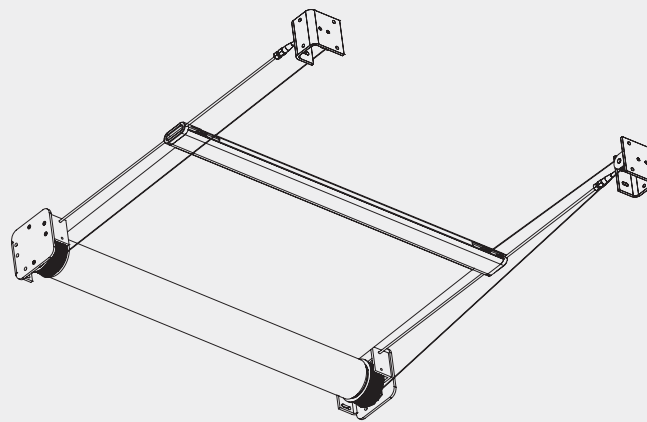

### Product Information

- Wire guided tension roller blind
- Electrically operated and fully retractable
- For sloping and horizontal glazing applications
- Suitable for applications between 0° and 360°
- Specially selected fabrics available
- Aluminium parts powder coated white as standard
- Fasteners and cables in corrosion resistant stainless steel
- Can be combined with Radio Remote Control System Silent Gliss 9940/0450



8600

Supplied by

**SG-S** | Silent Gliss Spares  
Silent Gliss Systems

www.sg-s.co.uk email: sales@sg-s.co.uk tel: 01395 232528

## Profile and Specification Information

### Headrail

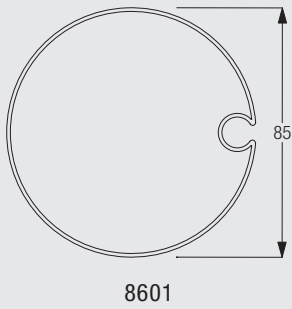

### Bottom bar

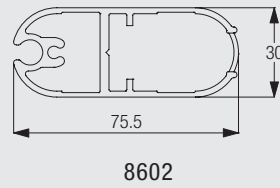

### Specification Information - download from Silent Gliss Extranet

8600 electrically operated tension roller blind skylight system ready assembled with motor. Complete with tension cables, return brackets, with fabric ..... Quantity....., width.....mm x drop.....mm. Wall/ceiling fixing brackets.

## Measuring and Planning

### How to measure

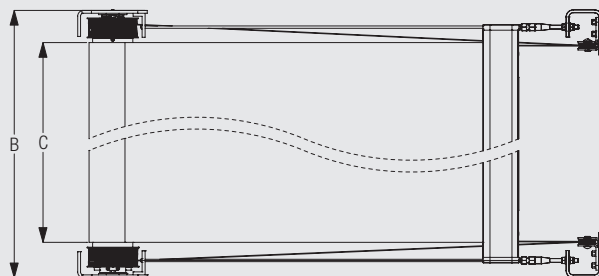
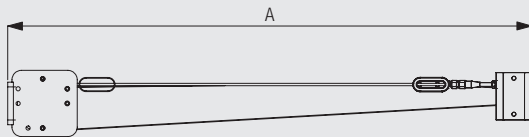

- A: System length
- B: System width
- C: Fabric width (B - 145mm)

Pulling force per bracket: typical 100kg tensile load

8600

## System orientation

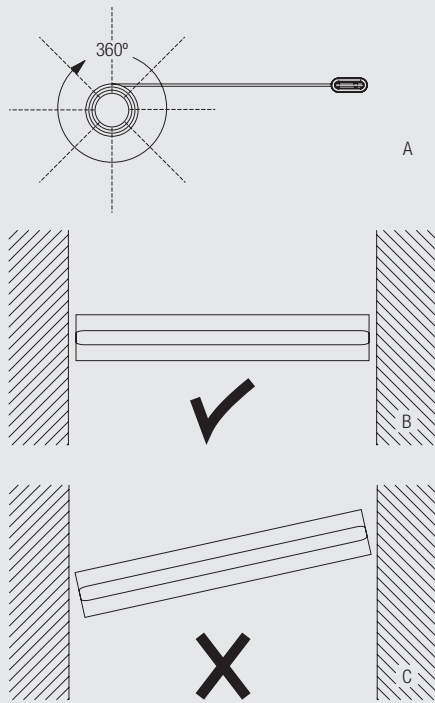

Side elevation of headrail showing fabric.

A: Fabric pull possible at any angle (0 - 360°) from the centre line of the roller tube.

Vertical section of diagonal axis (B + C)

B: System headrail can only be installed horizontally.

C: System headrail cannot be installed inclined.

## System Dimensions



4m



Up to length of 3m =  
87cm  
Over length of 3m =  
108cm



6.5m



18sqm



40kg

## Loading chart

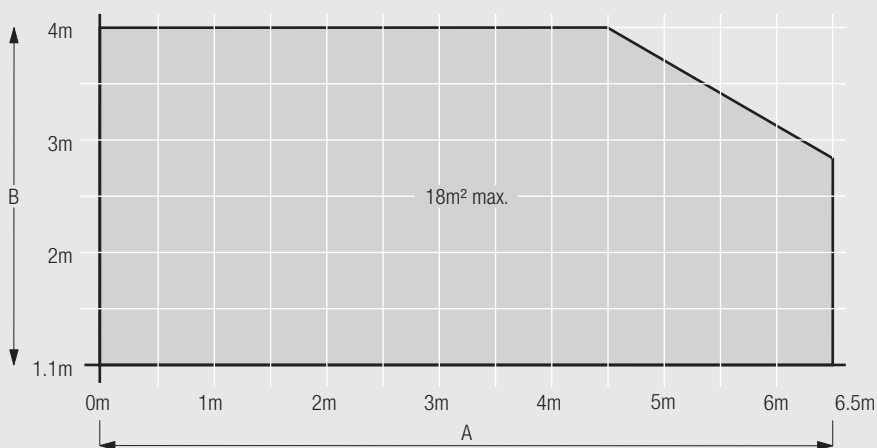

A: System length  
B: System width



8600

## System Options

### Multiple systems

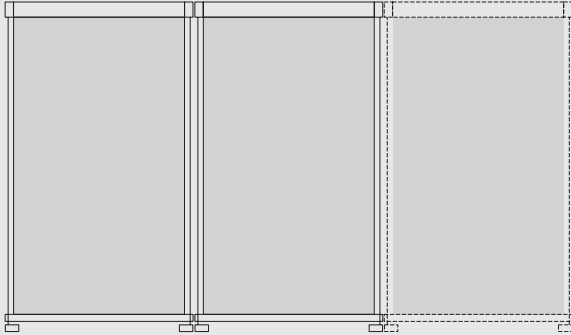

Each system requires its own motor.

## Fitting Information

### Ceiling fix

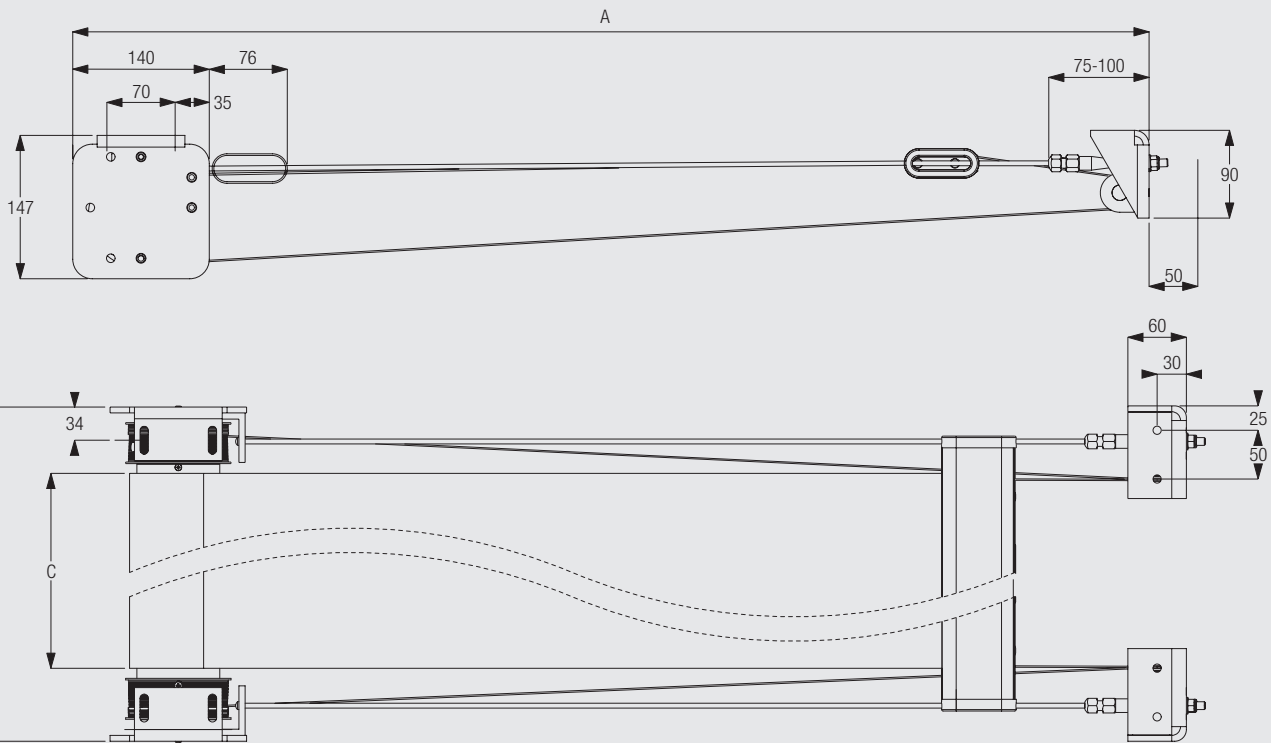

- A: System length
- B: System width
- C: Fabric width (B - 145mm)



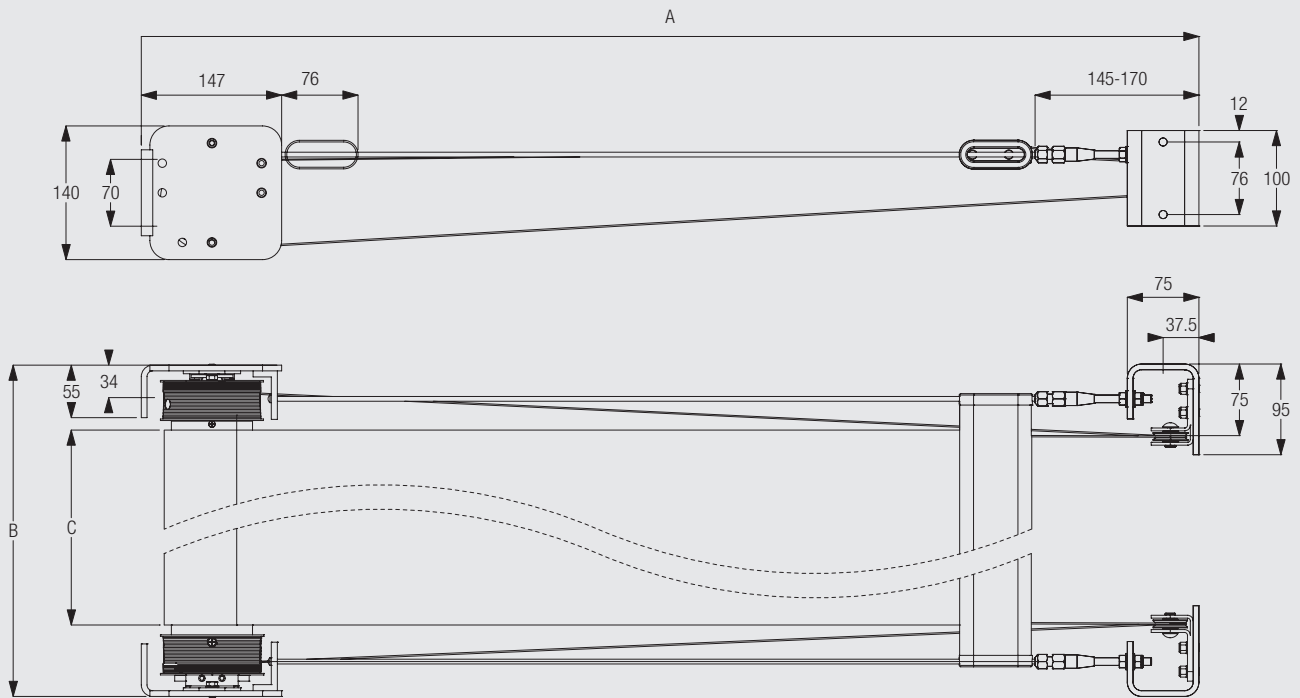

Note: ceiling fix return pulley requires 50mm back clearance.

## Wall fix

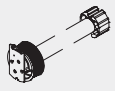

- A: System length
- B: System width
- C: Fabric width (B - 145mm)

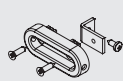
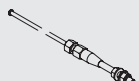
## Standard Accessories

			8601	Profile		 8600
8602	Profile		8603	Spring set short		
8604	Spring set long		8605	Motor set		
8606	Roller bracket ceiling left		8607	Roller bracket ceiling right		
8608	Pulley bracket ceiling left		8609	Pulley bracket ceiling right		
8611	Roller bracket wall left		8612	Roller bracket wall right		
8613	Pulley bracket wall left or right (reversible)		8614	Bottom bar pulley set		
8615	Bottom bar end cap set		8616	Wire guide set		
8617	Fabric insert (5mm)		8618	Fabric insert (6mm)		

8619 Tension wire (1.5mm)

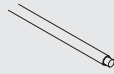

## Optional Accessories

0578 Pattress box



0615 Latching switch inc. pattress box



5741 Klik plug



5742 Klik socket



## Useful Measurements

8606 Roller bracket ceiling left

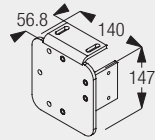

8607 Roller bracket ceiling right

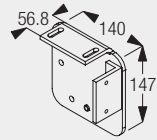

8608 Pulley bracket ceiling left

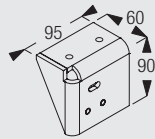

8609 Pulley bracket ceiling right

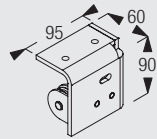

8611 Roller bracket wall left

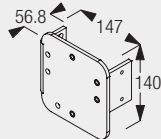

8612 Roller bracket wall right

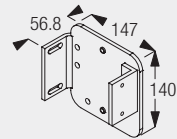

8613 Pulley bracket wall left or right (reversible)

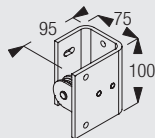

## Motorisation

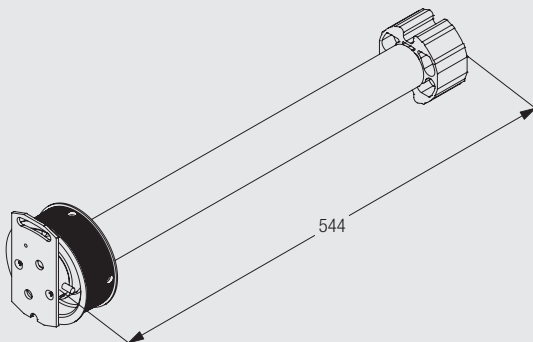

- Torque: 15Nm / 15Nm
- Voltage: 120V / 230V
- Frequency: 60Hz / 50Hz
- Power: 130W / 140W
- Current: 1.1A / 0.65A
- Speed: 18rpm / 17rpm
- Speed of travel: 7.5 cm per second
- Thermal overload protection
- Mechanical end stop

The Silent Gliss 8605 motor is an interference-free motor, designed to offer top performance in regard to strength and reliability. The entire motor is integrated in the tube. The motor will be supplied with 2.5m cable (white) with plug.

## Operating Methods

### Fixed Wall Switch

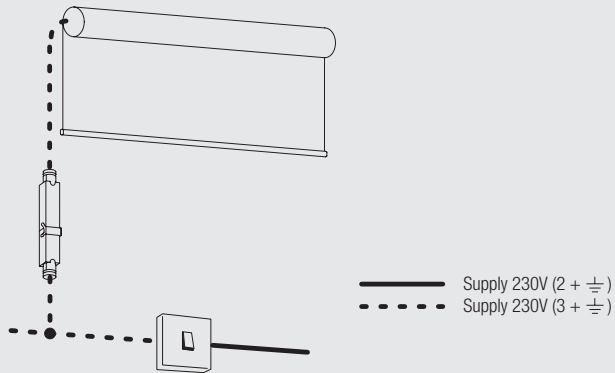

Relays (5736) must be used if **multiple systems** are connected in parallel.

When using the Fixed Switch control for multiple blinds, when operating simultaneously the blinds may not necessarily stop at precisely the same intermediate point. Top and bottom levels can be preset in alignment.

If this is a requirement then we recommend using Radio Control Systems 9940/0450 with individual and simultaneous switching.

### Radio Remote Control Systems Silent Gliss 9940/0450

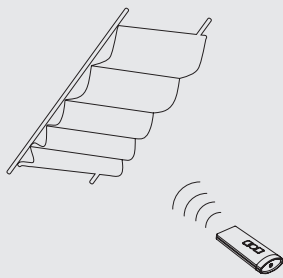

System can be combined with Radio Remote Control Systems Silent Gliss 9940/0450 with minimum wiring. For further details, please refer to catalogue section "Motors & Controls".

## Wiring and Connections

**Important:** Wiring diagrams are available on the Silent Gliss website [www.silentgliss.co.uk](http://www.silentgliss.co.uk) (password required). Please contact Silent Gliss for information on access.



8600

Supplied by



www.sg-s.co.uk email: sales@sg-s.co.uk tel: 01395 232528

[www.silentgliss.co.uk](http://www.silentgliss.co.uk)

[www.silentglissglobal.com](http://www.silentglissglobal.com)

Silent Gliss Ltd  
Pyramid Business Park  
Poorhole Lane  
Broadstairs  
Kent  
CT10 2PT  
Great Britain

Tel: +44 (0) 1843 863571  
Fax: +44 (0) 1843 864503  
info@silentgliss.co.uk

Silent Gliss Global Ltd  
Pyramid Business Park  
Poorhole Lane  
Broadstairs  
Kent  
CT10 2PT  
Great Britain

Tel: +44 (0) 1843 874250  
Fax: +44 (0) 1843 874457  
info@silentglissglobal.com