

# User Manual

March 2012

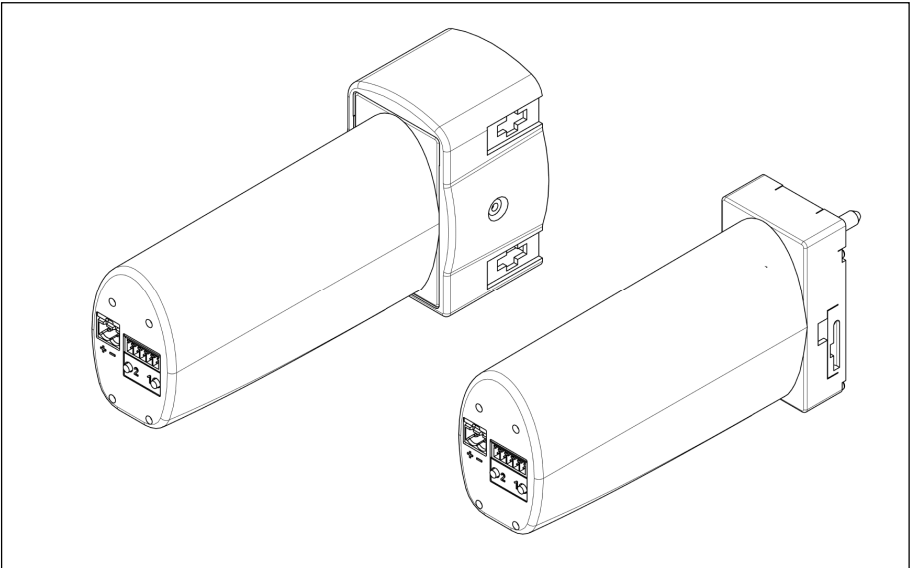

## Motors

Silent Gliss® 9040 / 41 (for Systems Silent Gliss 5200/5220)

Silent Gliss® 9090 / 91 (for Systems Silent Gliss 2650/2950)

Copyright by Silent Gliss International Ltd., 3073 Gümligen/Berne (Switzerland)  
Realised by Silent Gliss International, Group Headquarters

Printed in Switzerland

Supplied by  
**SG-S** | Silent Gliss Spares  
Silent Gliss Systems  
[www.sg-s.co.uk](http://www.sg-s.co.uk) email: [sales@sg-s.co.uk](mailto:sales@sg-s.co.uk)  
Tel: 0330 1272002 - 01395 232528

## Table of Contents

Please read chapters "intended application" and "Safety Instructions" before installing or connecting. Non-observance as well as opening and manipulation of the motor will result in voiding of the Silent Gliss liability and warranty.

1	Introduction and Product Overview	4
2	Intended Application	4
3	Safety Instructions	5
4	Technical Specifications	5
5	Programming and Operating of SG 9040/41 and SG 9090/91	9
6	Troubleshooting	13
7	Warnings	14
8	Notes	15

# 1 Introduction and Product Overview

This User Manual describes the setting up and programming of the different motor types, which are used in connection with the Silent Gliss Electrical Curtain Track System SG 5200, SG 5220, SG 2650 and SG 2950 as well as with the Radio Remote Control System SG 9940. Please refer to the separate fitting instruction and wiring diagrams for the installation of the System SG 5200, SG 5220, SG 2650 and SG 2950.

## 1.1 Motor variations

SG Nr.	ERP Nr.	Description
9040	100904000	Motor 24V DC
9041	100904100	Motor 24V DC, radio 868 MHz
9041	100904101	Motor 24V DC, radio 915 MHz
9041	100904102	Motor 24V DC, radio 433,9 MHz
9090	100909000	Motor 24V DC
9091	100909100	Motor 24V DC, radio 868 MHz
9091	100909101	Motor 24V DC, radio 915 MHz
9091	100909102	Motor 24V DC, radio 433,9 MHz

## 2 Intended Application

- The motors may only be used in combination with the designated Silent Gliss systems.
- The motors are designed for indoor use. Application in wet areas like bathrooms, indoor swimming-pools, saunas etc. is not permitted.
- Please note that the Radio Control Systems are not permitted in certain locations such as Hospitals and Airports.
- Please ensure that other equipment is not being controlled by radio equipment using the same frequency.

### 3 Safety Instructions

- The motors may be used only in dry rooms.
- The motors may not be used in explosive areas.
- The motors are not intended for use by young children or infirm persons without supervision.
- Only original Silent Gliss parts may be used.
- The installation, inspection and troubleshooting of the drive mechanism may only be performed by qualified specialists. Please consider the country specific regulations in regards of connection of the power supply to the mains.
- The proper operation of the motor in combination with the electric curtain track systems is only guaranteed with professional installation, mounting, as well as sufficient electric power supply.
- Cleaning of the motor may only be performed if the motor is disconnected from the mains voltage.
- The motor must not be used if cables, plugs or the motor are damaged.
- Please ensure that the detailed specification below meets the applicable regulation of the specified country and that the radio frequency is appropriate for that country

### 4 Technical Specifications

Motor type.	SG 9040 / 41.	SG 9090 / 91
Voltage Supply Regulated	24 VDC	24 VDC
Current	1.9 A	1.9 A
Frequency of radio control	868 / 915 or 433.9 MHz	868 / 915 or 433.9 MHz
Speed	110 rpm	110 rpm
Dimension Motor	197x 91x 63 mm	167x 80x 46 mm
Dimension Power Supply	110x 53x 30 mm	110x 53x 30 mm
Weight	0.5 kg	0.5 kg
Temperature for operation	0° C to + 60° C	0° C to + 60° C
Safety class	IP 40	IP 40

## 4.1 Wiring Diagram

See separate Wiring Diagram instruction

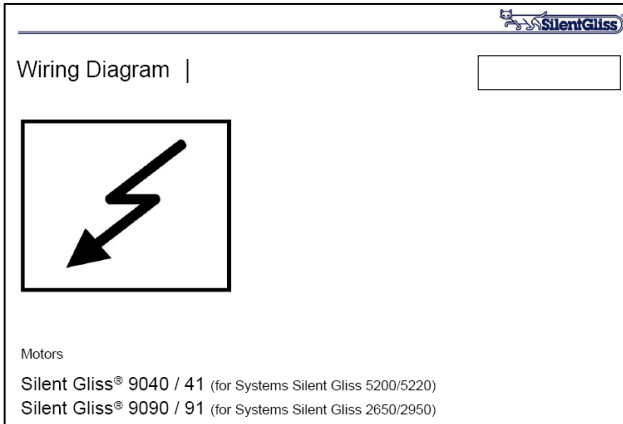

## 4.2 Connection and Operating Equipment

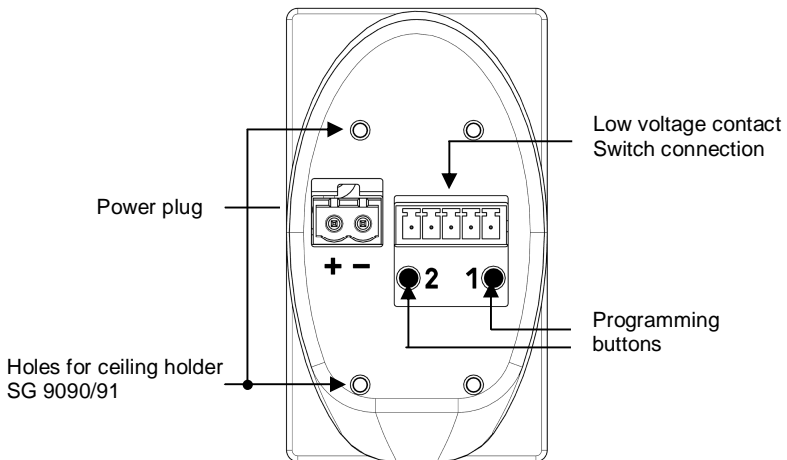

### 4.3 Low Voltage Contact Switch Connections

Used for control by low voltage dry contact closure, group control or for the connection of the programming cable.

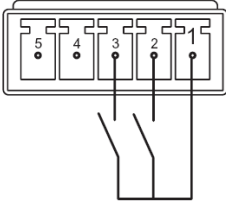

Pin	Denotation
1	Common
2	Open – Single (Latching Switch)
3	Close – Single (Latching Switch)
4	Open – Group (Latching Switch)
5	Close – Group (Latching Switch)

### 4.4 Programming Buttons

Used for the programming of the endstops.

The numbers of the buttons are marked on housing of the motors.  
The right button is nr. 1, the left nr. 2.

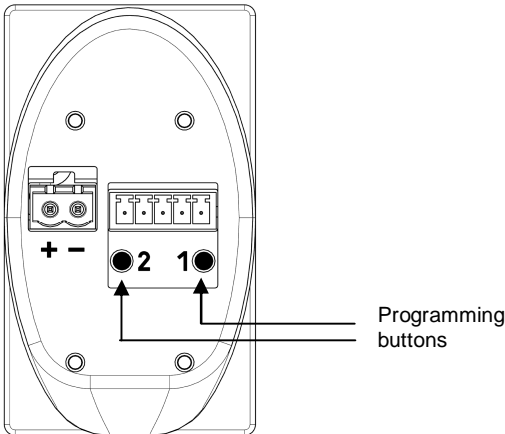

## 4.5 Mains Connection (24 VDC)

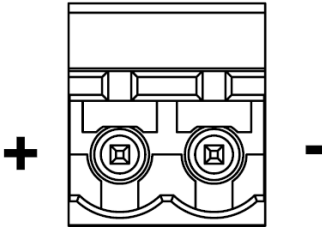

## 4.6 Power Supply

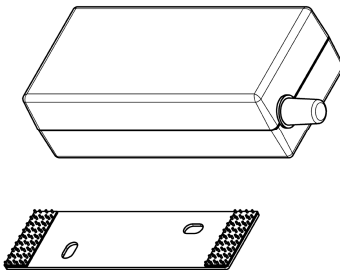

- The motor receives the power from an external power supply.
- The 24VDC cable is 2.9 meter long and the plug is already fitted.
- Power Supply and cable are white.
- Power Supply input: AC 100-240V / 50-60Hz
- Power Supply output: Regulated DC 24V / 45W



## 5 Programming and Operating of SG 9040/41 and SG 9090/91

### 5.1 Main Overview

After installation of a motor onto the designated Silent Gliss track, the end stops positions can be programmed. These programming can be carried out in several ways: by means of the programming buttons on the motor, by means of the optional available programming cable SG 5651 or by means of the Radio Remote Control System SG 9940.

### 5.2 Programming by means of Programming Buttons on Motor or Programming Cable SG 5651

The following table shows the different steps required to program the final stops. If the programming cable SG 5651 is used to program the end stops, it is required to plug it into the Dry Contact Switch connection before programming.

Step	To do	Result
1	Disconnect power supply of the motor for 5 seconds and make sure that the motor will have permanent power when reconnected. Typically unplug power lead from motor.	
2	Reconnect power and simultaneously push programming button 1 or 2	Acoustic Signal
3	Simultaneously press both buttons (1&2) and hold depressed for at least 6 seconds. After 3 seconds motor will sound. Do not release both buttons. Wait until motor sounds for the second time. Motor is then in programming mode for 3 minutes.	Acoustic Signal after 3 and 6 seconds.
4	Use programming button 1 to drive the system to the first end stop position. Then press both buttons simultaneously for at least 3 seconds until you hear the acoustic signal. This end position is then stored.	Acoustic Signal
5	Use programming button 2 to drive the system to the other end stop position. Then press both buttons simultaneously for at least 3 seconds until you hear the acoustic signal. This end position is then stored.	Acoustic Signal

### 5.3 Programming with Radio Remote Controls SG 9941 and SG 9942

The remote control has to be taught-in with the motor before the programming of the end positions by means of the radio remote control system can be performed. This can be carried out with the following steps. Please refer to the user manual, which is enclosed with every delivered remote control.

Step	To do	Result
1	Disconnect power supply of the motor for 5 seconds and make sure that the motor will have permanent power supply when reconnected. Typically unplug power lead from motor.	
2	Move the curtain with button 1 or 2 on the motor about to the middle position of the two endstops.	
3	Select the desired channel by pressing the select button (only 9942).	Channel LED on remote control lights on.
4	Position yourself in front of the motor with the remote control in your hand, and open the front cover of the device and press button "P".	Curtain moves independently approx. 2 minutes open and close.
5	To define the allocation of the buttons press the first button on the transmitter as soon as the curtain begins to move in the first direction.	The curtain will come to a briefly hold.
6	As soon as the curtain begins to move again, press the second button on the handheld remote control. The remote control has been successfully programmed.	The curtain will come to a stop.

## Adjusting the endpositions

Step	To do	Result
1	Disconnect power supply of the motor for 5 seconds and make sure that the motor will have permanent power when reconnected.	
2	Reconnect power and simultaneously push programming button 1 or 2 on the motor.	Acoustic Signal
3	Select the desired channel by pressing the select button (only SG 9942)	Channel LED on remote control lights on
4	Simultaneously press programming buttons on the remote control (1&2) and hold depressed for at least 6 seconds. After 3 seconds motor will sound. Do not release both buttons. Wait until motor sounds for the second time. Motor is then in programming mode for 3 minutes.	Acoustic Signal after 3 and 6 seconds.
5	Use programming button 1 on the remote control to drive the system to the first end stop position. Then press both buttons on the remote control simultaneously for at least 3 seconds until you hear the acoustic signal. This end position is then stored.	Acoustic Signal
6	Use programming button 2 on the remote control to drive the system to the other end stop position. Then press both buttons on the remote control simultaneously for at least 3 seconds until you hear the acoustic signal. This end position is then stored.	Acoustic Signal

## 5.4 Programming by means of other Silent Gliss remote controls or remote wall switches

Refer to these specific user manuals.

## 5.5 Resetting of Motor to Factory Status

Step	To do	Result
1	Disconnect power supply of the motor for 5 seconds and make sure that the motor will have permanent power when reconnected.	
2	Reconnect power and simultaneously push programming button 1 or 2 on the motor.	Acoustic Signal
3	Simultaneously press both buttons (1&2) and hold depressed for at least 6 seconds. After 3 seconds motor will sound. Do not release both buttons. Wait until motor sounds for the second time. Motor is then in programming mode for 3 minutes.	Acoustic Signal after 3 and 6 seconds.

## 5.6 Deleting Radio Remote Control 9941 (1 Channel)

Step	To do	Result
1	Make sure that the motor has permanent power.	
2	Open the front cover on the device and press the following buttons simultaneously: → Programming button P + Stop button.	
3	Keep these two buttons pressed until the LED goes out briefly.	LED turns off short

## 5.7 Deleting Radio Remote Control 9942 (5+1 Channel)

Step	To do	Result
1	Make sure that the motor has permanent power.	
2	Deleting of a specified channel Select the channel to be deleted. Then open the front cover and press the following buttons simultaneously: → Programming button P + Stop button.	
3	Keep all of these buttons pressed until the LED flashes off short	LED flashes off short
2a	Deleting of all channels Select all Channel. Open the front cover and press the following buttons simultaneously: → Programming button P + UP + Stop + Down button.	
3a	Keep all of these buttons pressed until the LED flashes off 3x.	LED flashes off short

## 6 Troubleshooting

- The motor does not move?
  - Check if motor is correctly supplied with power according to the wiring diagram.
- The motor does not move after saving the first end stop?
  - Disconnect power. Start limit setting process again (see point 5) ensuring that button 1 is used first to drive the system to its first limit position.
- The motor turns in the wrong direction with dry contact switching (permanent power)
  - Exchange cable of pin 2 with 3 at the dry contact switch terminal connection.

## 7 Warnings

It is important for the safety of persons to follow these instructions. Save these instructions.

### Usage

- Appliance is not to be used by children or persons with reduced physical, sensory or mental capabilities, or lack of experience and knowledge, unless they have been given supervision or instruction.
- Children being supervised not to play with appliance.
- Do not allow children to play with fixed controls. Keep remote controls away from children.
- Frequently examine the system for imbalance and signs of wear or damage to cables and installation. Do not use if repair or adjustment is necessary.

### Installation

- Before installing the drive, remove any unnecessary cords and disable any equipment not needed for powered operation.
- Install the actuating member of a manual release at a height less than 1.8 m.
- If a fixed control device is used, it must be mounted visible.
- The used external power source, must be a safety insulated transformer or safety insulated power switching device with an output voltage of DC 24V regulated and an minimum output current of 1.2A (ED20% 5min).
- If an external power source is used, which one is not fitted with means for disconnection from the supply mains having a contact separation in all poles that provide full disconnection under overvoltage category III (min. 3.0 mm), or the main plug must be accessible.

## 8 Notes

.....

.....

.....

.....

.....

.....

.....

.....

.....

.....

.....

.....

.....

.....

.....

.....

.....

.....

.....

.....

.....

.....

.....

.....

Supplied by  
**SG-S** | Silent Gliss Spares  
          | Silent Gliss Systems  
www.sg-s.co.uk   email: sales@sg-s.co.uk  
Tel: 0330 1272002 - 01395 232528

[www.silentgliss.com](http://www.silentgliss.com)

Silent Gliss International Ltd.  
Worbstrasse 210  
3073 Gümligen

Tel : +41 (0) 31 958 85 85  
Fax : +41 (0) 31 958 85 86  
[info@silentgliss.com](mailto:info@silentgliss.com)