

Shower Rail System

Silent Gliss® 1085

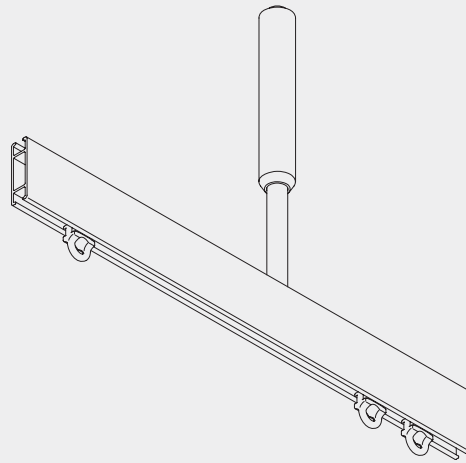

Product Information

- For use as a shower rail only, not suitable for room divider/cubicle
- Attractive reversible rail with varied fixing possibilities
- For medium weight curtains
- Wide application for showers
- Available as a shower rail in kits
- Satin silver anodised finish only
- 4m lengths only



1085

Supplied by

SG-S | Silent Gliss Spares
Silent Gliss Systems

www.sg-s.co.uk email: sales@sg-s.co.uk tel: 01395 232528

Profile, Bending and Specification Information

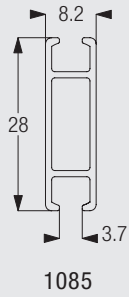

Standard radius 200mm.

The standard radius is recommended for optimal operation. The minimum possible radius is 150mm.

Specification Guide - download from www.silentgliss.co.uk (password required).

Silent Gliss 1085 room divider system, anodised aluminium rail type 1085, secured to fittings detailed as follows. Allow for noggins in suspended ceiling / hollow partitions elsewhere in B of Q. Pre-forming bend in running length 90/135 degrees. Nylon glider/hook 3533C fitted to track at 10/ metre. Nylon wall support 3652 screwed/plugged and screwed to wall and fitted to track using endstop 3017. 3610S hanger rod system, anodised aluminium, drop m once screwed through ceiling to noggin above and secured to track with 3699 insert.

System Layout Options

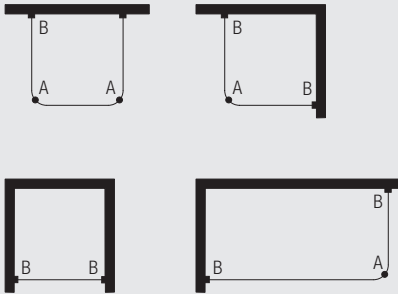

A: hanger rod 3610S
B: wall support 3652



For straight applications hanger rods are not necessary except for extra strength on lengths above 6'/183cm. For pre-packed kits, refer to application chart.

1085

Fitting Options

Ceiling fix with hanger rod 3610S

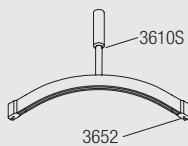
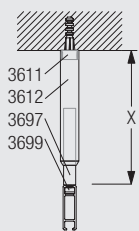

	X (m)
3610S	1.22

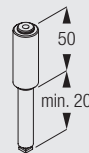

3610S
Hanger rod assembly

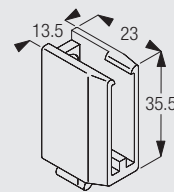

3652
Wall support

Wall fix with wall support 3652

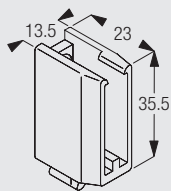
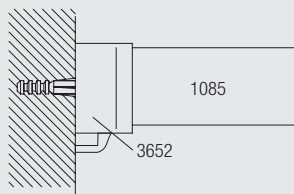

3652
Wall support

Standard Accessories

1085 Profile



3017 Endstop



3652 Wall support



3533C Glider with hook



Standard Accessories - Sets

3610S Hanger rod assembly

3697 Rod

1

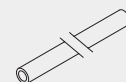

3698 Washer

1

3611 Stud

1



3612 Support with screw

1



3699 Track insert

1



1085

Optional Accessories

3070 Twist eye endstop



3071 Screw twist endstop



3533 Glider



3534 Glider 3533 in strip form



3570 Rotating glider



6146 Hook



Useful Information

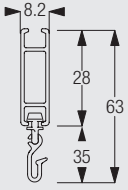

Diagram uses standard glider/hook combination 3533C. For glider 3570 the lower dimension will be 5.4mm.



1085

Supplied by



www.sg-s.co.uk email: sales@sg-s.co.uk tel: 01395 232528

www.silentgliss.co.uk

www.silentglissglobal.com

Silent Gliss Ltd
Pyramid Business Park
Poorhole Lane
Broadstairs
Kent
CT10 2PT
Great Britain

Tel: +44 (0) 1843 863571
Fax: +44 (0) 1843 864503
info@silentgliss.co.uk

Silent Gliss Global Ltd
Pyramid Business Park
Poorhole Lane
Broadstairs
Kent
CT10 2PT
Great Britain

Tel: +44 (0) 1843 874250
Fax: +44 (0) 1843 874457
info@silentglissglobal.com